

KC-Z1/RC-Z1

SERVICE MANUAL

© 1996-5/B51-5196-00 (K/K) 1506

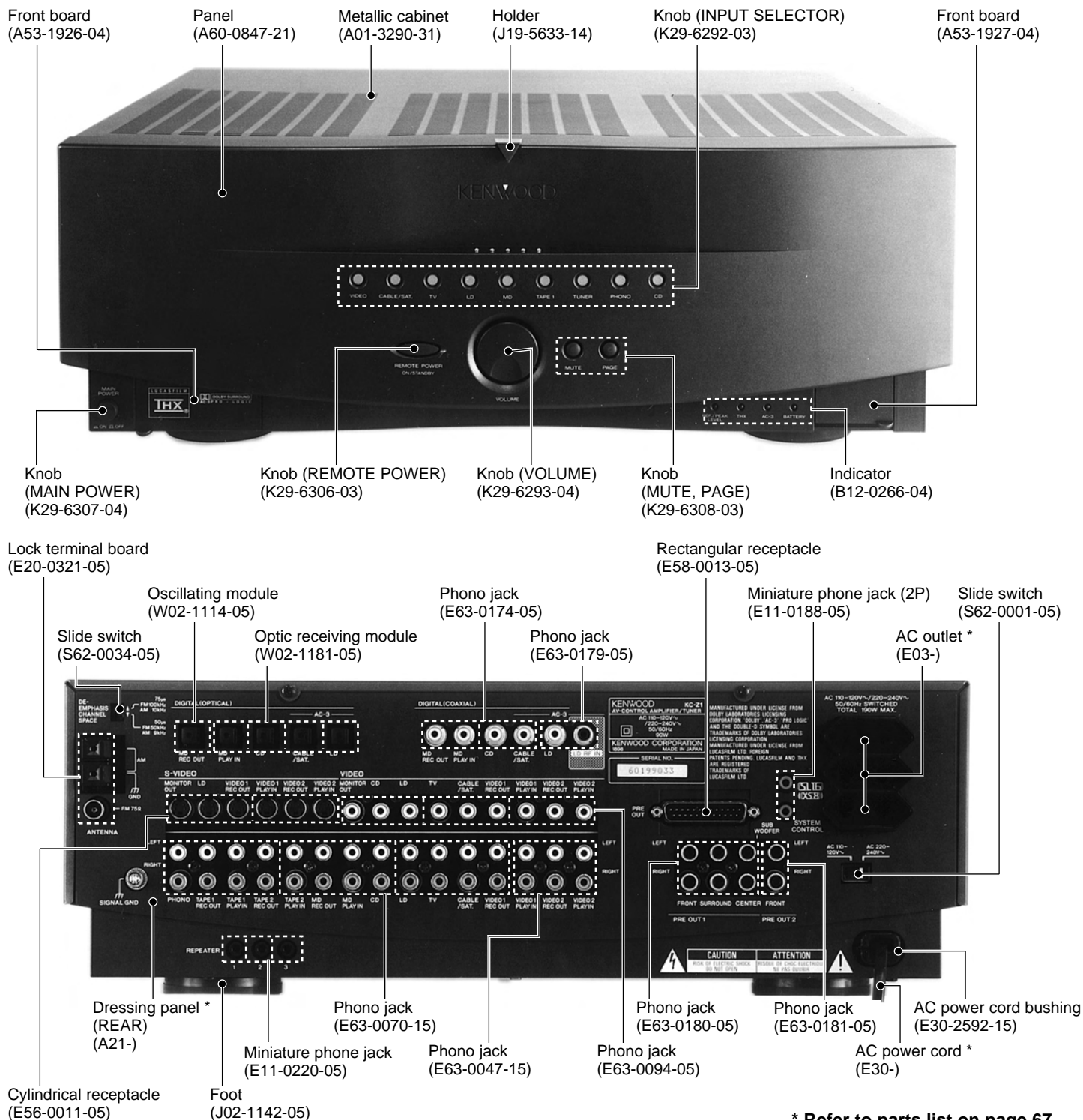

* Refer to parts list on page 67.

[RC-Z1 Reset method]

⊙@ All clear : While pressing the volume up and down key both, then remove and set the battery or push the reset button on the rear cover by ball point pen.

⊙A RC-Z1 clear (contrast, sleep timer etc) : While pressing mute key, then remove and set the battery or push the reset button on the rear cover by ball point pen.

CONTENTS / ACCESSORIES

Contents

CONTENTS / ACCESSORIES	2	WIRING DIAGRAM	19
LCD CONTROLLER	3	PC BOARD	21
DISASSEMBLY FOR REPAIR	4	SCHEMATIC DIAGRAM	33
BLOCK DIAGRAM	5	EXPLODED VIEW	65
CIRCUIT DESCRIPTION	7	PARTS LIST	67
ADJUSTMENT	17	SPECIFICATIONS	85

Accessories

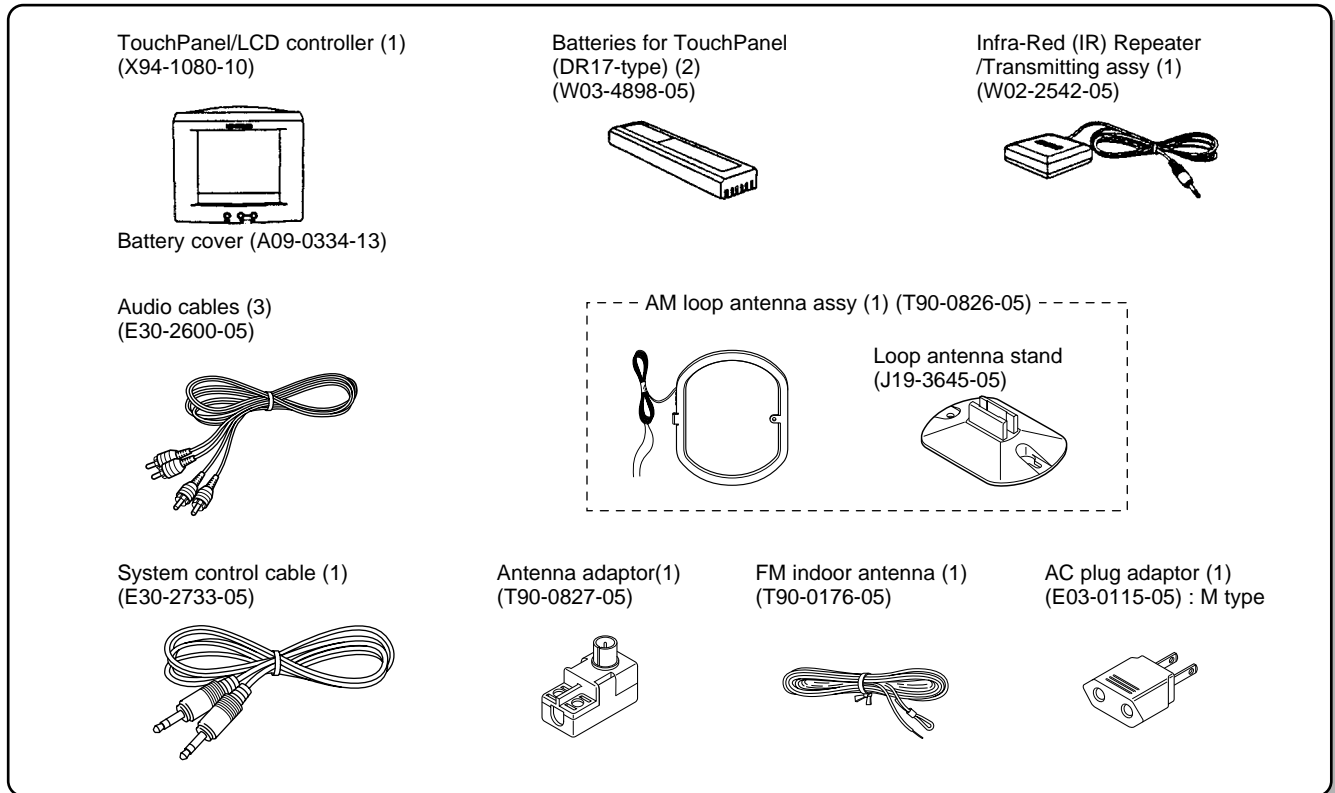

Instruction manual

	Parts No.Ö@	Parts No.ÖA	Destination
ENGLISH	B60-2476-00	B60-2758-00	K, M
FRENCH	B60-2477-00	B60-2759-00	K
CHINESE	B60-2478-00	B60-2760-00	M
TAIWANESE	B60-2479-00	B60-2761-00	M
SPANISH	B60-2724-00	B60-2762-00	M

LCD CONTROLLER



When you activate the Touch Panel for the first time, the Touch the Target screen appears. This screen helps calibrate the TouchPanel so it can detect the exact center of each button.

Touch the center of each target as it moves around the screen.

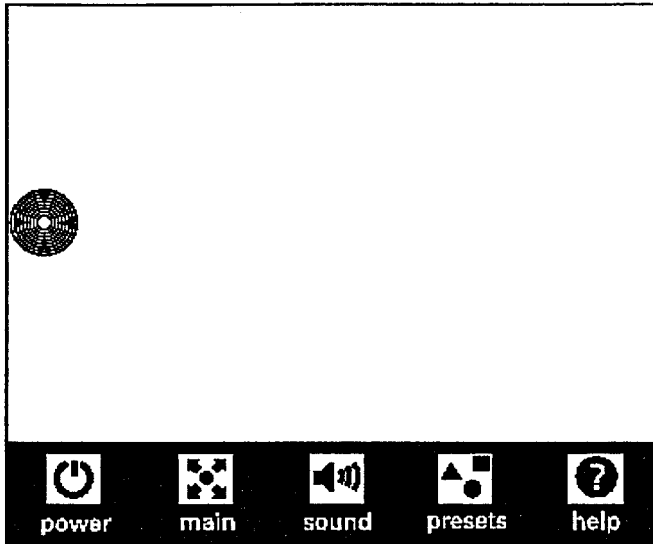

After you are finished calibrating the TouchPanel, the Stage 3 Title Screen display for a short time, followed by the MAIN MENU screen :

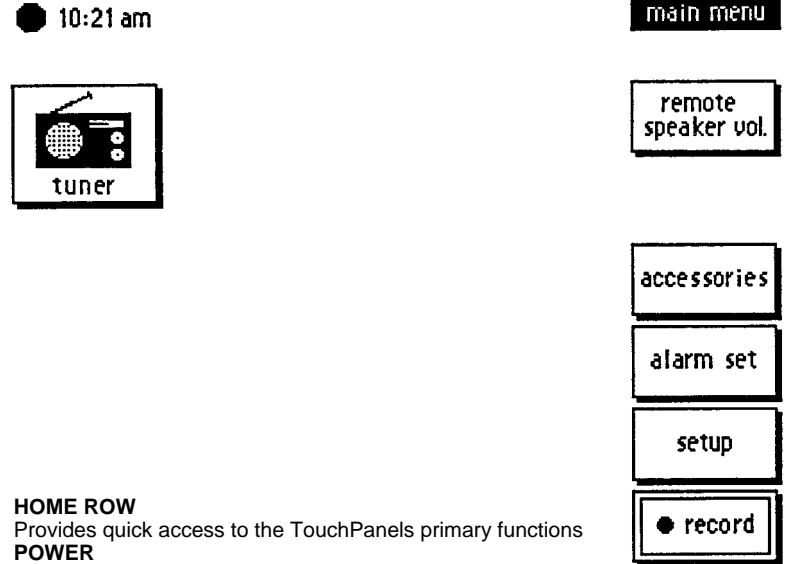

- **HOME ROW**
Provides quick access to the TouchPanels primary functions
 - **POWER**
Powers-down the Stage 3 Controller
 - **MAIN**
Lets you listen to and control all of the components in your home theater system
 - **SOUND**
Gives you total control over the way your system sounds
 - **PRESETS**
Enables you to save any changes you make with the SOUND buttons(and more)as system presets for instant recall
 - **HELP**
Gives you quick information on how the TouchPanel buttons work in the different screens
- SELECTION BUTTONS**
Allow you to activate or adjust different functions
- SYSTEM COMPONENT ICONS**
Lets you select and control your system components. Once you have set-up the TouchPanel, the MAIN MENU will show a separate icon for each component in your system
- RF COMMUNICATIONS ICON**
This icon appears on every TouchPanel screen
- TouchPanel is docked
 TouchPanel is receiving communication
 TouchPanel is not receiving communication
- SCREEN NAME**
Corresponds to the button you touched to activate the current screen
- VOLUME CONTROL AND MUTE BUTTONS**
The TouchPanel's volume and mute buttons are always available, no matter which screen you are using

You are now ready to customize the TouchPanel to operate your entire home theater system.

DISASSEMBLY FOR REPAIR

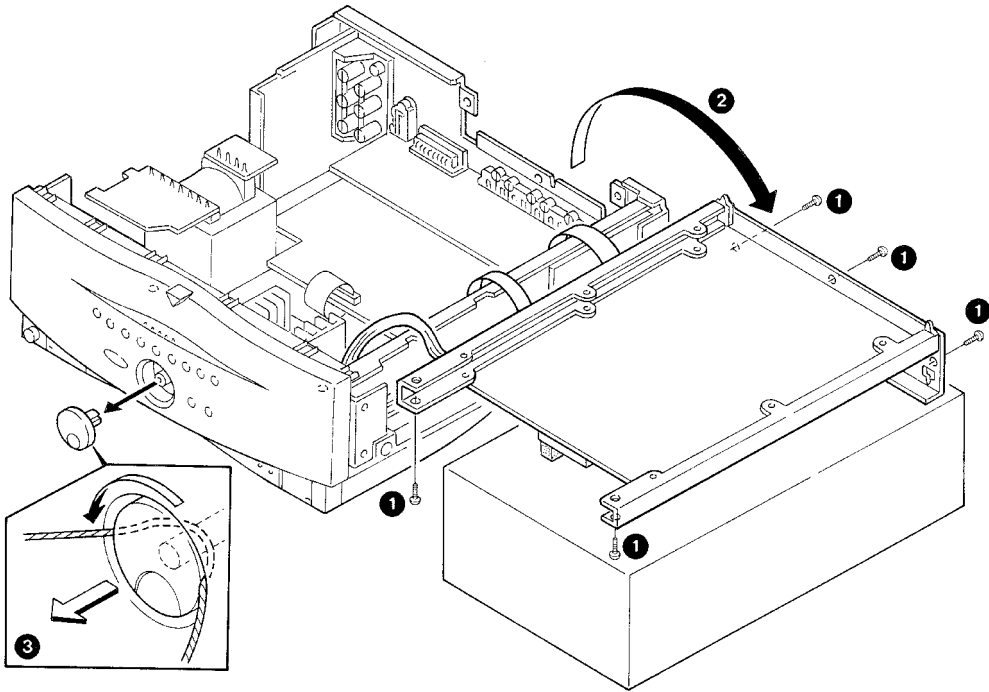

- (1) Remove 5 screws (❶), then remove the X08 PCB (❷).
- (2) Round a string on the volume shaft (❸), remove the volume knob.

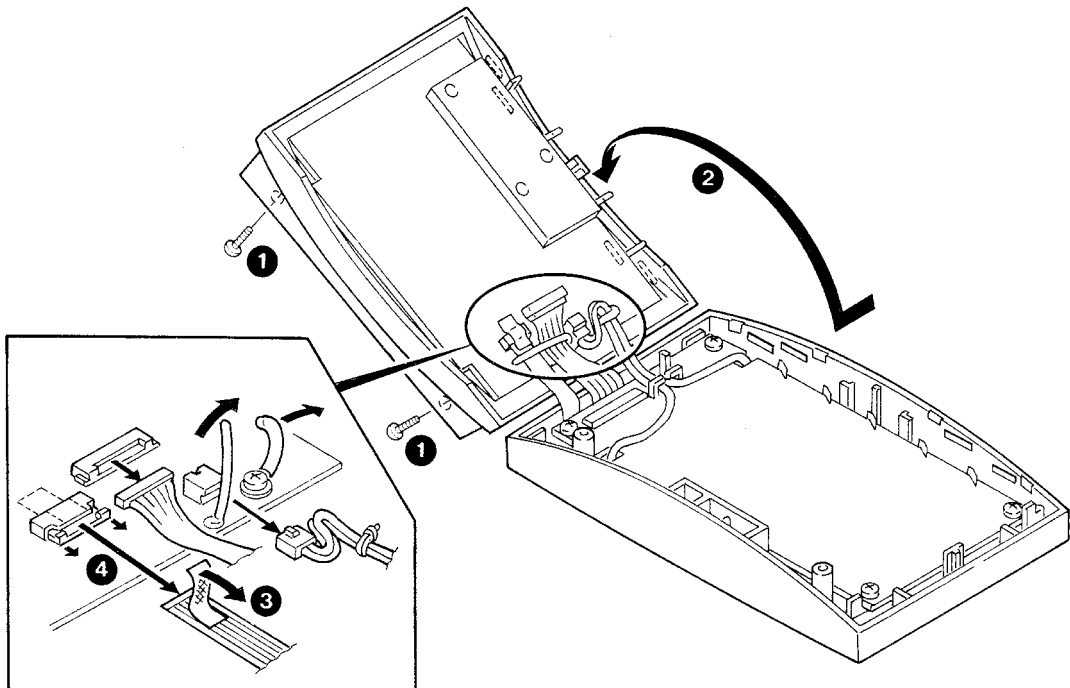

RC-Z1

- (1) Remove 2 screws (❶), then remove the rear cover (❷).
- (2) Tearing off non-woven fabric (❸), remove the flexible flat cable (FFC) (❹).

BLOCK DIAGRAM

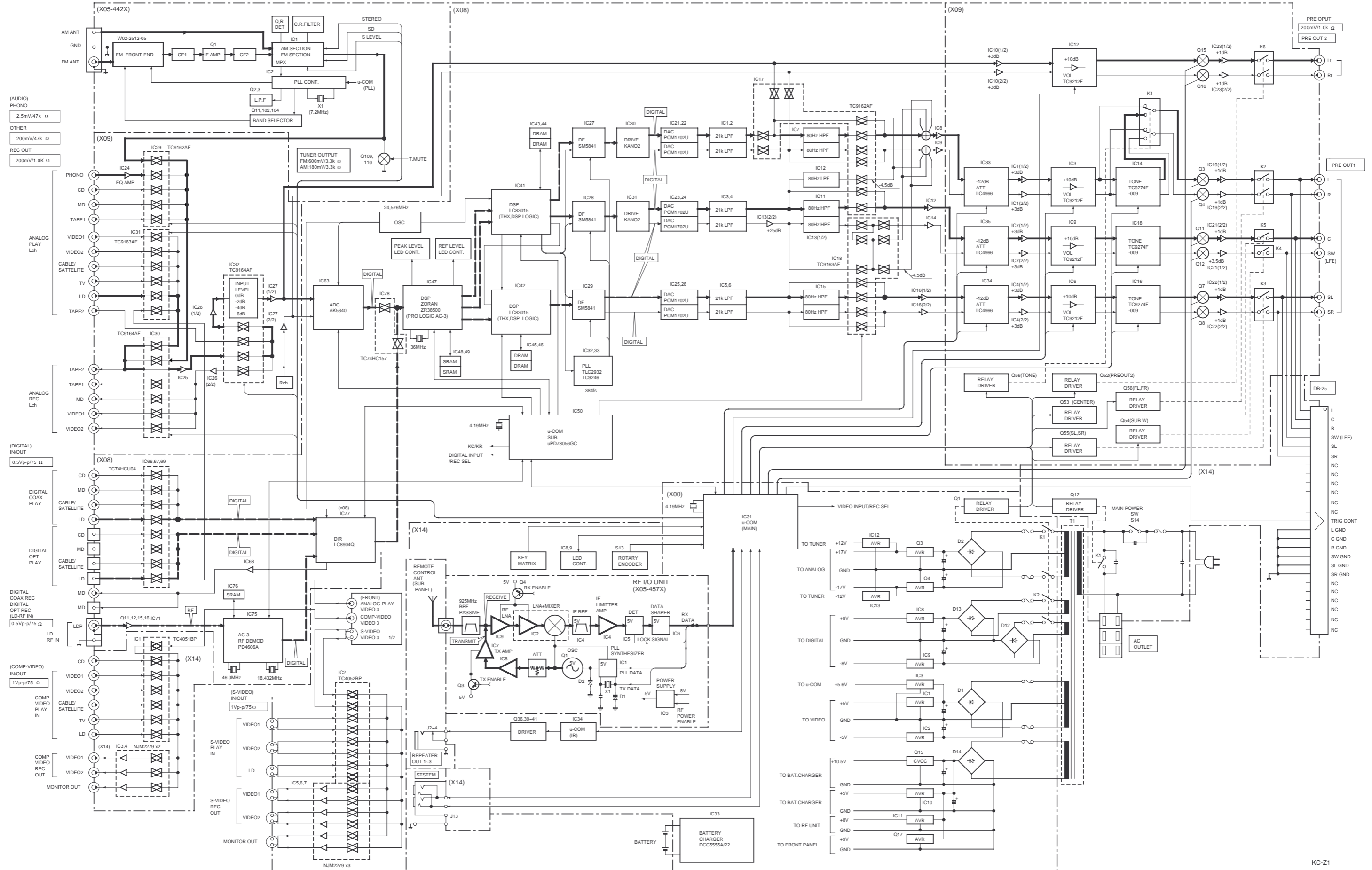

CIRCUIT DESCRIPTION

1. Main microprocessor : 78P078GF1ABA (X00 : IC 31)

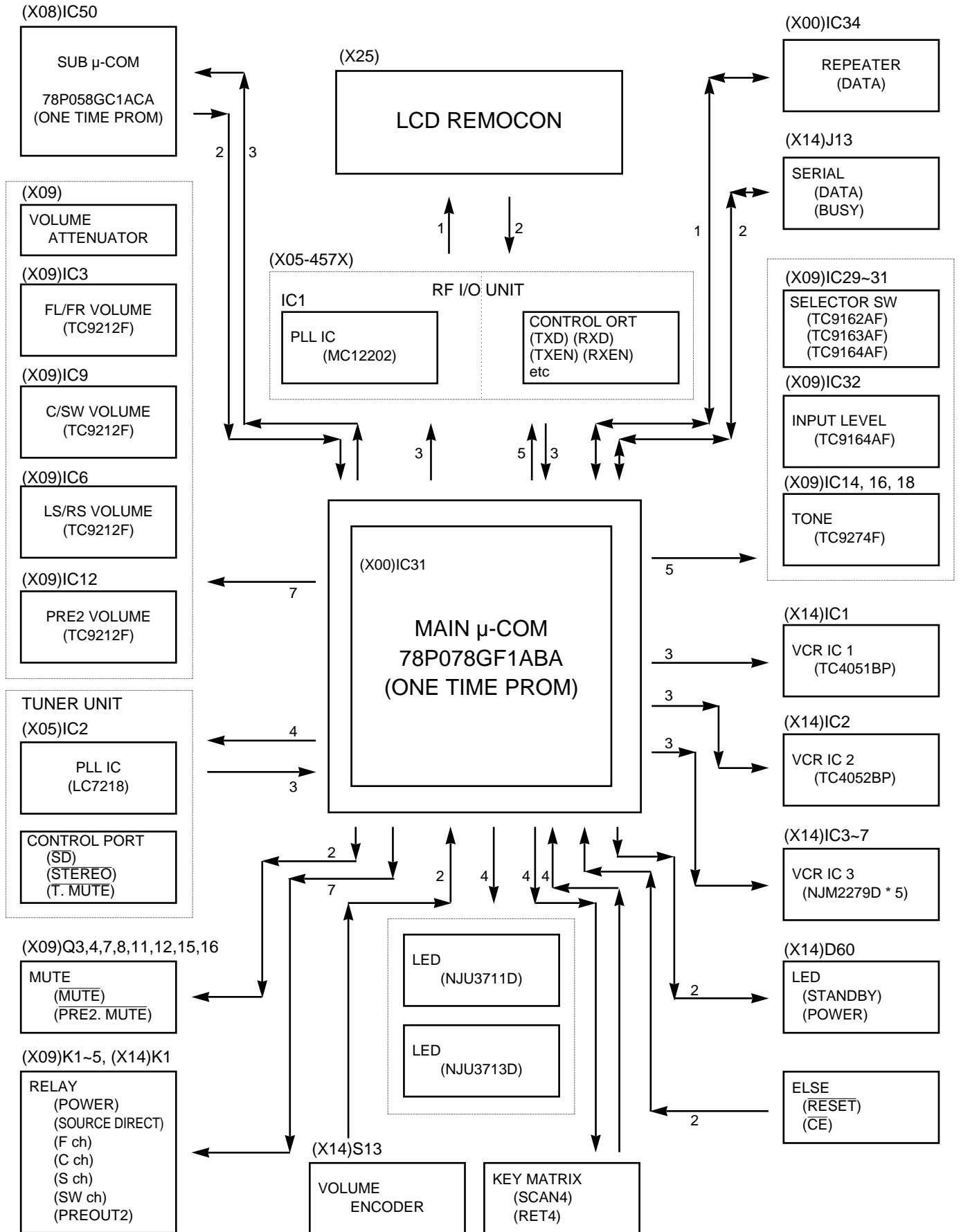

CIRCUIT DESCRIPTION

1-2. Pin description

PinNo.	Pin Name	I/O	Description	
1	V3.SW1	O	VCR IC3 (NJU2279D) switch1 port	
2	V2.B	O	VCR IC2 (TC4052BP) B port	
3	V2.A	O	VCR IC2 (TC4052BP) A port	
4	V1.C	O	VCR IC1 (TC4051BP) C port	
5	V1.B	O	VCR IC1 (TC4051BP) B port	
6	V1.A	O	VCR IC1 (TC4051BP) A port	
7	S.DATA	I/O	Serial communication data	
8	S.BUSY	I/O	Serial communication busy	
9	VSS		GND	
10	X2		Main system clock (4.15MHz)	
11	X1	I	Main system clock (4.15MHz)	
12	VDD		Power supply (+5V)	
13	XT2		Sub system clock (32.768KHz)	
14	XT1	I	Sub system clock (32.768KHz)	
15	RESET	I	System reset	
16	CE	I	Chip enable	
17	R.DATA	I/O	Repeater data	
18		I	Not used	
19	P.LOCK	I	RF unit lock signal	
20	POWER.LED	O	Power LED	
21	STANDBY.LED	O	Standby LED	
22	RDS.CK	I	Not used	
23	AVDD		A/D converter analog power supply (+5V)	
24	AVREF0		A/D converter base voltage (GND)	
25	RDS.SL	I	Not used	
26	RDS.NL	I	Not used	
27	P.SDT	O	RF unit PLL IC (LMX1511TMX) data	
28	P.SCK	O	RF unit PLL IC (LMX1511TMX) clock	
29	P.SLE	O	RF unit PLL IC (LMX1511TMX) load enable data	
30	P.LOCK	I	RF unit lock signal	H : ACTIVE
31	P.HOOK	I	LCD controller hook check	H : NONE L : HOOK
32	P.OSCEN	O	RF unit oscillator enable	H : ACTIVE
33	AVSS		VSS (GND)	
34	P.RXEN	O	RF unit receive enable	L : ACTIVE
35	P.TXEN	O	RF unit transmit enable	L : ACTIVE
36	AVREF1	I	D/A converter base voltage VDD (+5V)	
37	P.RXD	I	RF unit roam , controller receive data	
38	P.TXD	O	RF unit controller , roam transmit data	
39	P.RF	O	RF unit RF power	H : ACTIVE
40	VSS	-	GND	
41	S.DT	I	Main & sub U-COM communication sub U-COM transmit data	
42	M.DT	O	Main & sub U-COM communication main U-COM transmit data	
43	M.CK	O	Main & sub U-COM communication main U-COM clock	
44	M.RQ	O	Main & sub U-COM communication main U-COM request	
45	S.RQ	I	Main & sub U-COM communication sub U-COM request	
46	PRE2.MUTE	O	Preout 2 mute	
47	MUTE	O	Mute (Preout 1 mute)	

CIRCUIT DESCRIPTION

PinNo.	Pin Name	I/O	Description
48	PRE2.RLY	O	Preout 2 relay
49	SW.RLY	O	Sub woofer (SW) ch. relay
50	S.RLY	O	Surround (SL,SR) ch. relay
51	C.RLY	O	Center (C) ch. relay
52	F.REY	O	Front (FL,FR) ch. relay
53	L.RLY	O	Source direct relay
54	VOL.ATT	O	Volume attenuator
55	VOL.ST4	O	Preout1 FL/RFch volume IC (TC9212F) strobe
56	VOL.ST3	O	Preout 1 LS/RS ch.volume IC (TC9212F) strobe
57	VOL.ST2	O	Preout 1 C/SW ch. volume IC (TC9212F) strobe
58	VOL.ST1	O	Preout 2 FL/FR ch. volume IC (TC9212F) strobe
59	VOL.CK	O	Preout 1,2 volume IC (TC9212F) clock
60	VOL.DT	O	Preout 1,2 volume IC (TC9212F) data
61	A.ST3	O	Tone IC (TC9274F) strobe
62	A.ST2	O	Input selector (TC9162AF/TC9163AF/TC9164AF) strobe
63	A.ST1	O	Tape2 input IC (TC9164AF) level strobe
64	A.CK	O	Tone (TC9274F) /input selector (TC9162AF/TC9163AF) /tape 2(TC9164AF) clock
65	A.DT	O	Tone (TC9274F) /input selector (TC9162AF/TC9163AF) /tape 2(TC9164AF) data
66	P.RLY	O	Power relay
67	LED.ST2	O	LED control IC (NJU3713D) strobe
68	LED.ST1	O	LED control IC (NJU3711D) strobe
69	LED.CK	O	LED control IC (NJU3711D/NJU3713D) clock
70	LED.DT	O	LED control IC (NJU3711D/NJU3713D) data
71	VSS		GND
72	VOL.CW	O	Volume rotary encoder CW (A port)
73	VOL.CCW	O	Volume rotary encoder CCW (B port)
74-77	KR0-KR3	I	Key return 0-3
78-81	KS0-3	O	Key scan 0-3
82-85		I	Not used
86	RDS.DT	I	Not used
87	RDS.ST	I	Not used
88	RDS.RT	O	Not used
89	RDS.AT	O	Not used
90	RDS.SS	O	Not used
91	$\overline{T.MUTE}$	O	Tuner mute
92	T.CE	O	Tuner unit PLL IC (LC7218) chip enable
93	T.CK	O	Tuner unit PLL IC (LC7218) clock
94	T.DT	O	Tuner unit PLL IC (LC7218) data in
95	$\overline{T.ST}$	I	Tuner stereo
96	$\overline{T.SD}$	I	Tuner SD
97	$\overline{T.DO}$	I	Tuner unit PLL IC (LC7218) data out
98	V2.INH	O	VCR IC 2 (TC4052) inhibit port
99	V3.SW3	O	VCR IC 3 (NJU2279D) switch 3 port (monitor mute) H : MUTE OFF L : MUTE ON
100	V3.SW2	O	VCR IC 3 (NJU2279D) switch 2 port

CIRCUIT DESCRIPTION

1-3. Key matrix (12KEY + 4 SW)

	⑦④ KR0	⑦⑤ KR1	⑦⑥ KR2	⑦⑦ KR3
⑦⑧ KS0	LD	TV	CABLE	VCR
⑦⑨ KS1	CD	BEEP	MUTE	POWER
⑧① KS2	MD	TAPE 1	TUNER	PHONO
⑧② KS3	DSW0	DSW1	DSW2	DSW3

*No. of : Port No. of μ -COM

1-4. Destination list of tuner

Table 5-1 Destination List of Tuner

Destination	BAND	Receive frequency range	channel space	IF	PLL reference frequency	Destination DSW(X14-)		
						DSW2	DSW1	DSW0
K1	FM	87.5MHz~108.0MHz	100kHz	10.7MHz	50kHz	0	0	0
	AM	530kHz~1700kHz	10kHz	450kHz	10kHz			
K2 (M)	FM	87.5MHz~108.0MHz	100kHz	10.7MHz	50kHz	0	0	1
	AM	530kHz~1610kHz	10kHz	450kHz	10kHz			

0 : Non Diode

1 : Diode

2. Sub microprocessor : 78P058GC1ACA (X08:IC50)

2-1. Microprocessor periphery block diagram

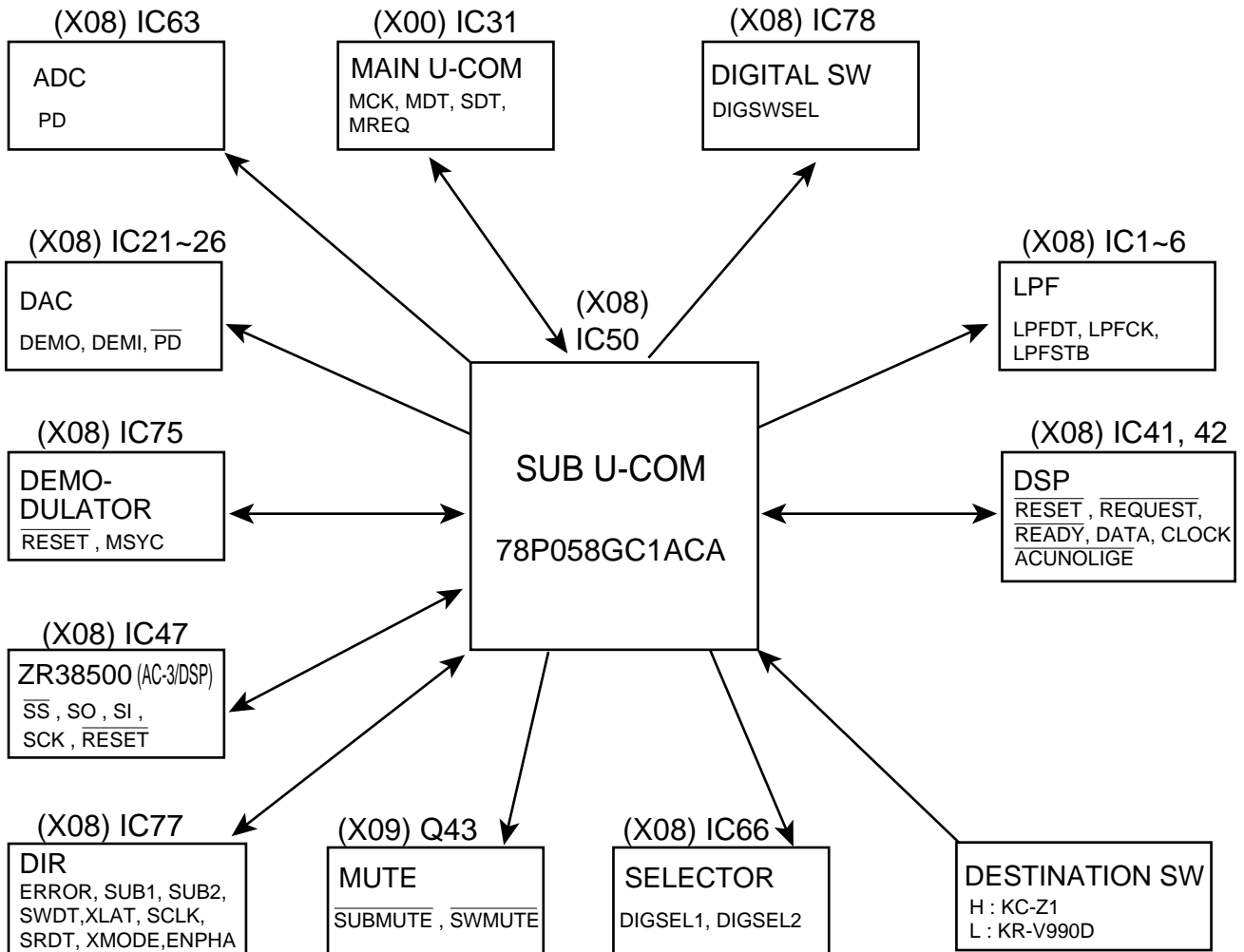

CIRCUIT DESCRIPTION

2-2. Pin description

PinNo.	Pin Name	I/O	Description	
1	DSP1REQ	O	DSP IC1 (LC83015JE):(X08:IC41) request	
2	DSP1AK	I	DSP IC1 (LC83015JE):(X08:IC41) acknowledge	
3	DSP2RST	O	DSP IC2 (LC83015JE):(X08:IC42) reset	
4	AVSS		A/D reference voltage (GND)	
5	DSP2RDY	O	DSP IC2 (LC83015JE):(X08:IC42) ready	
6	DSP2REQ	O	DSP IC2 (LC83015JE):(X08:IC42) request	
7	AVREF1		A/D reference voltage (VDD)	
8		I	Not used	
9	DSP1DT/DSP2DT	O	DSP IC1,2 (LC83015JE) data	
10	DSP1CK/DSP2CK	O	DSP IC1,2 (LC83015JE) clock	
11	MDT	I	Master data (communicated with main u-com)	
12	SDT	O	Slave data (communicated with main u-com)	
13	MCK	I	Master clock (communicated with main u-com)	
14	MREQ	I	Master request (communicated with main u-com)	
15	SREQ	O	Slave request (communicated with main u-com)	
16	ZRSI	I	ZR38500 slave data	
17	ZRSO	O	ZR38500 master data	
18	ZRCK	O	ZR38500 master clock	
19	ZRSS	O	ZR38500 strobe	
20	ZRRST	O	ZR38500 reset	
21	ADPD	O	ADC (AK 5340) power down	
22,23	DADEMO0,1	O	DAC (PCM1702U) sample rate select	
24	DAPD	O	DAC (PCM1702U) reset	
25	DEMST	O	Demodulator reset	
26		I	Not used	
27	DEMMSYC	I	Demodulator AC3 data sync check	H:AC3 SYNCRO L:ERROR
28-31		I	Not used	
32	PLLMUTE	I	PLL lock/unlock detect	
33	VSS	I	GND	
34	SUBMUTE	O	Sub mute	
35	SWMUTE	O	SW.mute	
36-40		I	Not used	
41	DIRSRDT	I	DIR (LC8904Q) channel stace output (32Bit)	
42	DIRCLK	O	DIR (LC8904Q) clock	
43	DIRLAT	O	DIR (LC8904Q) data latch	
44	DIRSWDT	O	DIR (LC8904Q) data	
45,46	DIRSUB1,2	I	DIR (LC8904Q) sample frequency output	
47	DIRERROR	I	DIR (LC8904Q) error check	H:ERROR L:PCM
48	DIRXMODE	O	DIR (LC8904Q) reset	
49	DIRENPHA	I	DIR (LC8904Q) emphasis	
50		O	Not used	
51	LPFSTB	O	SEL IC (TC9162N/TC9163N) data	
52	LPFCK	O	SEL IC (TC9162N) clock	
53	LPFDT	O	SEL IC (TC9162N) data	
54		I	Not used	
55	DIGSWSEL	O	TC74HC157 analog/digital selector	H:DIGITAL L:ANALOG

CIRCUIT DESCRIPTION

PinNo.	Pin Name	I/O	Description		
56,57	DIGSEL1	O	TC74HC153 digital input selector		
58	TYPESEL	I	Model distinction	H:KC-Z1	L:KR-V990D
59		I	Not used		
60	RESET	I	Sub u-com reset		
61-67		I	Not used		
68	VDD		Power supply (+5V)		
69-70	X2,X1		4.19MHz ceramics		
71	IC(VPP)		GND		
72	XT2	O	Not used		
73	XT1	I	Not used (GND)		
74	AVDD		Not used		
75	AVREF0		Not used		
76-77		I	Not used		
78	DSP2AK	I	DSP IC2 (TC83015JE):(X08:IC42) acknowledge		
79	DSP1RST	O	DSP IC1 (TC83015JE):(X08:IC41) reset		
80	DSP1RDY	O	DSP IC1 (TC83015JE):(X08:IC41) ready		

3. DSP (AC-3) : ZR38500-36 (X08 : IC47)

3-1. System block diagram

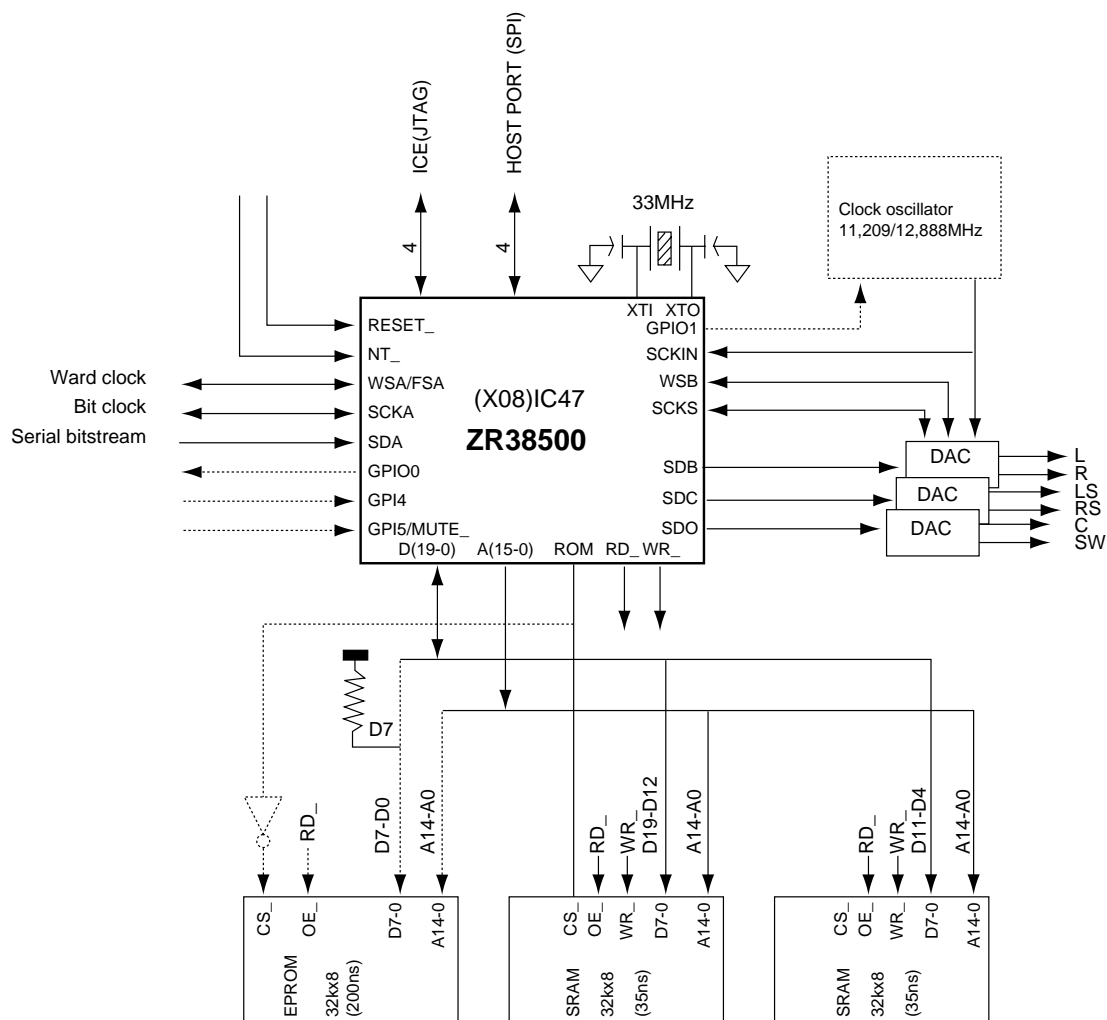

CIRCUIT DESCRIPTION

3-2. Pin function description

No.	Pin name	Type	No.	Pin name	Type	No.	Pin name	Type	No.	Pin name	Type
1	GND	P	33	GND	P	65	GND	P	97	GND	P
2	D6	I/O/T	34	NC		66	A11	O/T	98	SCKB	I/O
3	D7	I/O/T	35	NC		67	VCC	P	99	SCKA	I/O
4	D8	I/O/T	36	NC		68	A12	O/T	100	SCKIN	I/O
5	D9	I/O/T	37	VCC	P	69	A13	I/O	101	SDA	I
6	VCC	P	38	NC		70	A14	I/O	102	GN14	I
7	D10	I/O/T	39	NC		71	A15	I/O	103	VCC	P
8	NC		40	GND	P	72	NC		104	GP15/MUTE	I
9	GND	P	41	GND	P	73	VCC	P	105	SO	O
10	D11	I/O/T	42	TCK	I	74	NC		106	GND	P
11	VCC	P	43	VCC	P	75	GND	P	107	SDD	O
12	D12	I/O/T	44	TMS	I	76	GND	P	108	VCC	P
13	D13	I/O/T	45	GND	P	77	ROM	O/T	109	SDC	O
14	D14	I/O/T	46	GND	P	78	VCC	P	110	SDB	O
15	D15	I/O/T	47	TDI	I	79	NC		111	WSB/FSB	I/O
16	D16	I/O/T	48	VCC	P	80	INT_	I	112	SI	I
17	D17	I/O/T	49	SCK	I	81	GND	P	113	VCC	P
18	VCC	P	50	A0	O/T	82	XTO	O	114	VCC	P
19	D18	I/O	51	A1	O/T	83	XTI	I	115	SS_	I
20	GND	P	52	A2	O/T	84	GNDA	P	116	GND	P
21	GND	P	53	A3	O/T	85	VCCA	P	117	GND	P
22	D19	I/O/T	54	GND	P	86	VCC	P	118	GP100	I/O
23	VCC	P	55	A4	O/T	87	WR_	O	119	VCC	P
24	NC		56	VCC	P	88	GND	P	120	GPIO1	I/O
25	NC		57	A5	O/T	89	GND	P	121	D0	I/O/T
26	NC		58	A6	O/T	90	RD_	O	122	D1	I/O/T
27	NC		59	A7	O/T	91	VCC	P	123	D2	I/O/T
28	NC		60	A8	O/T	92	NC		124	D3	I/O/T
29	VCC	P	61	A9	O/T	93	RESET_	I	125	D4	I/O/T
30	NC		62	VCC	P	94	TDO	O/T	126	VCC	P
31	NC		63	A10	O/T	95	WSA/FSA	I/O	D5	D5	I/O/T
32	GND	P	64	GND	P	96	GND	P	128	GND	P

CAUTION 1) Connect the unused input pin (TYPE=I) to VCC if low when active. Connect it to GND of high when active.

CAUTION 2) Do not connect the unused output pin (TYPE=O), tristate pin (TYPE=T), and NC pin.

CAUTION 3) All data pins are internally pulled up to VCC by a minute current.

CIRCUIT DESCRIPTION

XTI, XTO

Crystal oscillator input/output pins. A parallel resonance oscillator for clock signal generation and two tuning capacitors are connected to these pins. The clock signal generated at the pins is sent to the internal PLL circuit. A clock signal can also be directly input to the XTI pin. The maximum frequency of an input clock signal is 33 MHz, and the minimum frequency is 7 MHz.

A(15:0)

Address buses. These address buses are usually active.

ROM

Memory selection signal (A18 pin of ROM/RAM and 38001DSP address bits). This signal is set active-high after reset and set low after the EROM boot program processing is completed.

D(19:0)

Data buses. These data buses are a bidirectional data bus for external memory access.

RD_

Read strobe pin. This pin is asserted when external memory is read.

WR_

Write strobe pin. This pin is asserted when data is written in external memory.

RESET_

Reset input pin. Using this reset signal, the execution starts from the prescribed status and address.

During the power-on sequence, this input pin must be asserted by more than 200 clocks so as to initialize a processor (cold start). VCC and XTI (clock input or crystal oscillator) pins must satisfy the prescribed DC and AC characteristics until the rising edge of a reset signal is reached. To secure the guard time until the normal operation is initiated after that, a processor is put into the idle state for 4,096 clocks. For other resets, that is, all resets after the power-on sequence, the device is reset when a reset input signal become active between four clocks (minimum) and 127 clock (maximum)(warm start). A processor is released from the reset state at the rising edge of a reset signal and put into the normal operation mode after two clocks.

INT_

External interrupt input pin. This interrupt signal is enabled when it is asserted by more than two XTI cycles.

WSA/FSA

Word selection or frame synchronization input/output pin of A-group serial port (for input). The direction and function of this signal are set by the SA, MA, and TA parameters (corresponding to the parameter in an SPMODE register for 38001DSP) of a CFG command described later.

SCK A

Clock input/output pin for A-group serial port. The direction of this signal is set by the MA bit of a CFG command.

SDA

Data input pin for serial port A

SCKIN

Clock input/output pin for B-group serial port. The direction of this signal is set by the CB bit of a CFG command.

WSB/FSB

Word selection or frame synchronization input/output pin for B-group serial port. The direction and function of this signal are set by the SB and MB bits of a CFG command.

SCKB

Clock input/output pin for B-group serial port. The direction of this signal is set by the MB bit of a CFG command.

SDB

Data output pin for serial port B

SDC

Data output pin for serial port C

SDD

Data output pin for serial port D

GPIO0, GPIO1

General-purpose pins. These pins can be set to the input or output state using a SETIO command.

GPI4

General-purpose input pin

GPI5/MUTE_

General-purpose input/mute pin. "1" is set to the MPE field of a CFG command when this pin is used as a mute pin.

SS_

Serial port interface: Slave select input (SPI).

SCK

Serial port interface: Clock input (SPI).

SO

Serial port interface: Serial data output (SPI).

SI

Serial port interface: Serial data input (SPI).

TCK

ICE interface clock (JTAG)

CIRCUIT DESCRIPTION

TMS

ICE interface mode selection (JTAG)

TDO

ICE interface data output (JTAG)

TDI

ICE interface data input (JTAG)

3-3. Operation Description

3-3-1. Power-on Sequence and Reset

To evade the collision of signals, the device sets all programmable bidirectional pins to the input mode for activation. For example, the serial ports in both groups A and B are set to the slave mode during activation. The operation mode must be set by a host controller so that it is suitable for each system configuration until decoding is initiated. Therefore, a CFG command is available.

During the power-on sequence or reset, the boot loader of an internal ROM is first activated. The program in EPROM is booted when the EPROM effective for address 0X40000 is detected. The program executed after booting can be specified by the data in EPROM.

When EPROM is not connected (any of lower-level data pins D7 to D0 is set high), the device jumps to the command processing routine of internal ROM so as to wait for the command from the host. The succeeding data from the host is processed in the same way as when it is booted from EPROM if the command sent from the host is booted. The device jumps to the specified address when downloading is completed.

3-3-2. External Interface Setting

The operation mode of a serial port and memory port is set using a CFG command. Set the operation mode according to the characteristics of ADC, DAC, DIR, and SRAM to be connected. The parameters described below can be set. The default value after reset is underlined>.

- Input port attribute: Master/slave
- Input port protocol: Continuous S (non-frame synchronization) /frame synchronization/word selection (12S compatible)/word selection (left-justify)/word selection (right-justify)
- Output port attribute: Master/slave
- Output port clock signal source: Internal/external
- Output port clock frequency-division coefficient: $WSB = \frac{SCKIN(256)}{SCKIN(384)}$
- DAC type: 12S/left-justify/right-justify
- DAC word size: 16/18/20 bits
- External SRAM bit width: Narrow (8/9/10 bits)/wide (16/18/20 bits)
- External SRAM speed: 0 wait/l wait

3-3-3. Operation Mode

This device supports the operation modes below. For the command and parameter that select each operation mode, refer to the description of host commands in section 4.

1) Pink noise

- Channel: Left, center, right, left surrounding, right surrounding, and sub-woofer

2) PCM

- Speaker configuration: Monaural and stereo

3) Dolby pro-logic

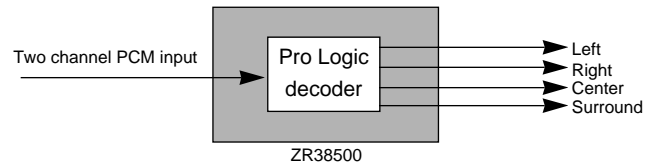

- Speaker configuration: Normal, wide, 3-stereo, and phantom

- Surrounding delay: Delayed in units of 1 ms between 0 and 31 ms.

4) Dolby AC3 + pro-logic

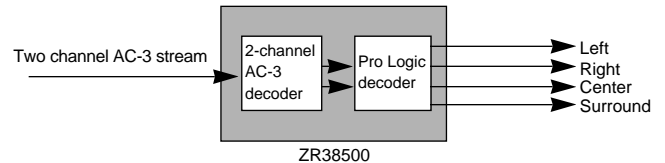

- Speaker configuration: Normal, wide, 3-stereo, and phantom

- Surrounding delay: Delayed in units of 1 ms between 0 and 31 ms.

- Input data format: Normal and S/P DIF

- Measures against data error: Mute and block repeat

5) Dolby AC3

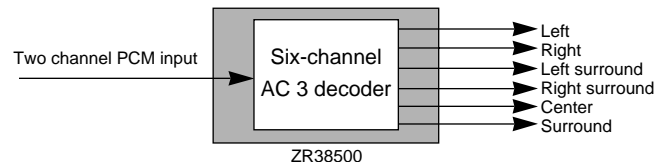

- Down mixing: 3/2, 2/2, 3/1, 2/1, 3/0, 2/0, and 1/0

- Surrounding delay: Delayed in units of 1 ms between 0 and 31 ms.

- Center delay: Delayed in units of 1 ms between 0 and 5 ms.

- Dynamic range control

- Input data format: Normal and S/P DIF

- Measures against data error: Mute and block repeat

3-3-4. Decoder Control

A decoder can be controlled as described below using a host command.

- Mute
- Stop
- Play

CIRCUIT DESCRIPTION

3-3-5. Decode Status

The information below can be accessed from the host during AC-3 decoding.

- Error status
- Audio frame information (Sampling rate, bit rate, mode, etc.)

3-3-6. Decoding Delay in AC-3 Mode

ZR38500 supports all the bit rates (32 kbps to 640 kbps) and sampling rates (32 kHz, 44.1 kHz, and 48 kHz) prescribed by AC-3 algorithm.

The decoding delay varies depending on how to enter the compressed data, the bit rate, and the sampling rate. However, the delay is fixed unless the parameter is changed.

The decoding delay can be given by the following expression.

AC-3 frame transfer time \times 2/3 (CRC check period) + period of one audio block (256 samples)

Example 1) For continuous bit stream

In this case, the clock at a serial data input port is the same as the bit rate and AC-3 data is input at a fixed rate. The decode delay at that time is fixed by the sampling rate as shown in Table 2.

Table 2 Decode Delay

Sampling rate	Decode delay
48 kHz	27 ms
44.1 kHz	29 ms
32 kHz	40 ms

Example 2) For burst transfer

When data is input using an S/P DIF interface, a burst transfer is used because the physical bit rate differs from the bit rate of information. In this case, the decode delay is determined by the physical interface bit rate, burst size, AC-3 bit rate, and sampling rate. The decode delay becomes approximately 11 ms when the sampling frequency is 48 kHz and when the bit rate is 384 kbps.

ADJUSTMENT

No.	ITEM	INPUT SETTINGS	OUTPUT SETTINGS	TUNER SETTINGS	ALIGNMENT POINT	ALIGN FOR	FIG.
REMOTE CONTROL RECEIVE / TRANSMIT (X05-4570-10) : KC-Z1 REMOTE CONTROL RECEIVE / TRANSMIT (X25-5690-10) : RC-Z1							
1	X'TAL FREQUENCY	-	Connect the frequency counter to X'tal check round.	<i>f</i> Receive 5ch(924.4MHz)	TC1	12.6MHz± 12.6Hz	(a)
2	LOCAL OSCILLATOR VT	-	Connect the DC voltmeter to VT check round.	<i>f</i> Receive 5ch(924.4MHz)	TC2	2.5±0.2V	(b)
3	ANTENNA MATCHING	-	(KC-Z1) Connect the speana to the antenna terminal. (924.2MHz center)	(KC-Z1) <i>f</i> Transmit 5ch(924.2MHz)	TC3	Maximum level of output spectrum	(c)
			(RC-Z1) Receive transmit frequency by speana input cable. (924.45MHz center)	(RC-Z1) <i>f</i> Transmit 5ch(924.4MHz)			
4	PLL DETECTOR CENTER	(KC-Z1) Remove the ANT (X05-4570), then connect FM-SG to the antenna terminal f : 924.4475MHz dev. : ±2.5kHz AF : 1.2kHz Level : 20dBμ/50Ω	Connect the DC voltmeter to PLL detector output check round.	(KC-Z1) <i>f</i> Receive 5ch(924.4MHz)	VR1	2.5±0.1V	(d)
		(RC-Z1) Output by FM-SG output cable. f : 924.1975MHz dev : ±2.5kHz AF : 1.2kHz Level : more than 70dBμ/50Ω		(RC-Z1) <i>f</i> Receive 5ch(924.2MHz)			

*f*Refer to Test mode on page 18.

ADJUSTMENT

f Test mode

	KC-Z1	RC-Z1
SETTING METHOD	Turn on the MAIN POWER Key while holding down the CD Key.	Insert the Battery into the RC-Z1 while holding down the volume up and DOWN key both.
CANCEL METHOD	Turn off the MAIN POWER.	Remove the Battery.
RECEIVE MODE	<p>Push CD Key, changeover cyclic receiving Ch.</p> <p>1 ch → 5 ch → 10 ch</p>	<p>Push the volume up or down Key, Then push the mute Key to decide.</p> <div style="display: flex; justify-content: space-around; align-items: flex-start;"> <div style="border: 1px solid black; padding: 2px 10px; margin: 5px;">tx</div> <div style="border: 1px solid black; padding: 2px 10px; margin: 5px;">tx55</div> <div style="border: 1px solid black; padding: 2px 10px; margin: 5px;">rx</div> </div> <div style="display: flex; justify-content: space-around; align-items: flex-start; margin-top: 10px;"> <div style="border: 1px solid black; padding: 2px 10px; margin: 5px;">1 ch</div> <div style="border: 1px solid black; padding: 2px 10px; margin: 5px;">5 ch</div> <div style="border: 1px solid black; padding: 2px 10px; margin: 5px;">10 ch</div> </div> <div style="display: flex; justify-content: space-around; align-items: flex-start; margin-top: 10px;"> <div style="border: 1px solid black; padding: 2px 10px; margin: 5px;">dummy</div> <div style="border: 1px solid black; padding: 2px 10px; margin: 5px;">display</div> <div style="border: 1px solid black; padding: 2px 10px; margin: 5px;">ram</div> </div> <p style="margin-top: 10px;">tx : TRANSMIT (Non Modulation) tx55:transmit (Modulation) rx : Receive</p>
TRANSMIT MODE	<p>Push MD key, Change over cyclic transmit Ch.</p> <p>1 ch → 5 ch → 10 ch</p>	

KC-Z1

RC-Z1

SETTING METHOD

Turn on the MAIN POWER Key while holding down the CD Key.

Insert the Battery into the RC-Z1 while holding down the volume up and DOWN key both.

CANCEL METHOD

Turn off the MAIN POWER.

Remove the Battery.

RECEIVE MODE

Push CD Key, changeover cyclic receiving Ch.

1 ch → 5 ch → 10 ch

LEDDISPLAY

THX AC-3

LED LED

1 Ch O X

5 Ch X O

10 Ch O O

(O : ON X:OFF)

Push the volume up or down Key, Then push the mute Key to decide.

tx

tx55

rx

1 ch

5 ch

10 ch

dummy

display

ram

tx : TRANSMIT
(Non Modulation)
tx55:transmit
(Modulation)
rx : Receive

TRANSMIT MODE

Push MD key, Change over cyclic transmit Ch.

1 ch → 5 ch → 10 ch

WIRING DIAGRAM

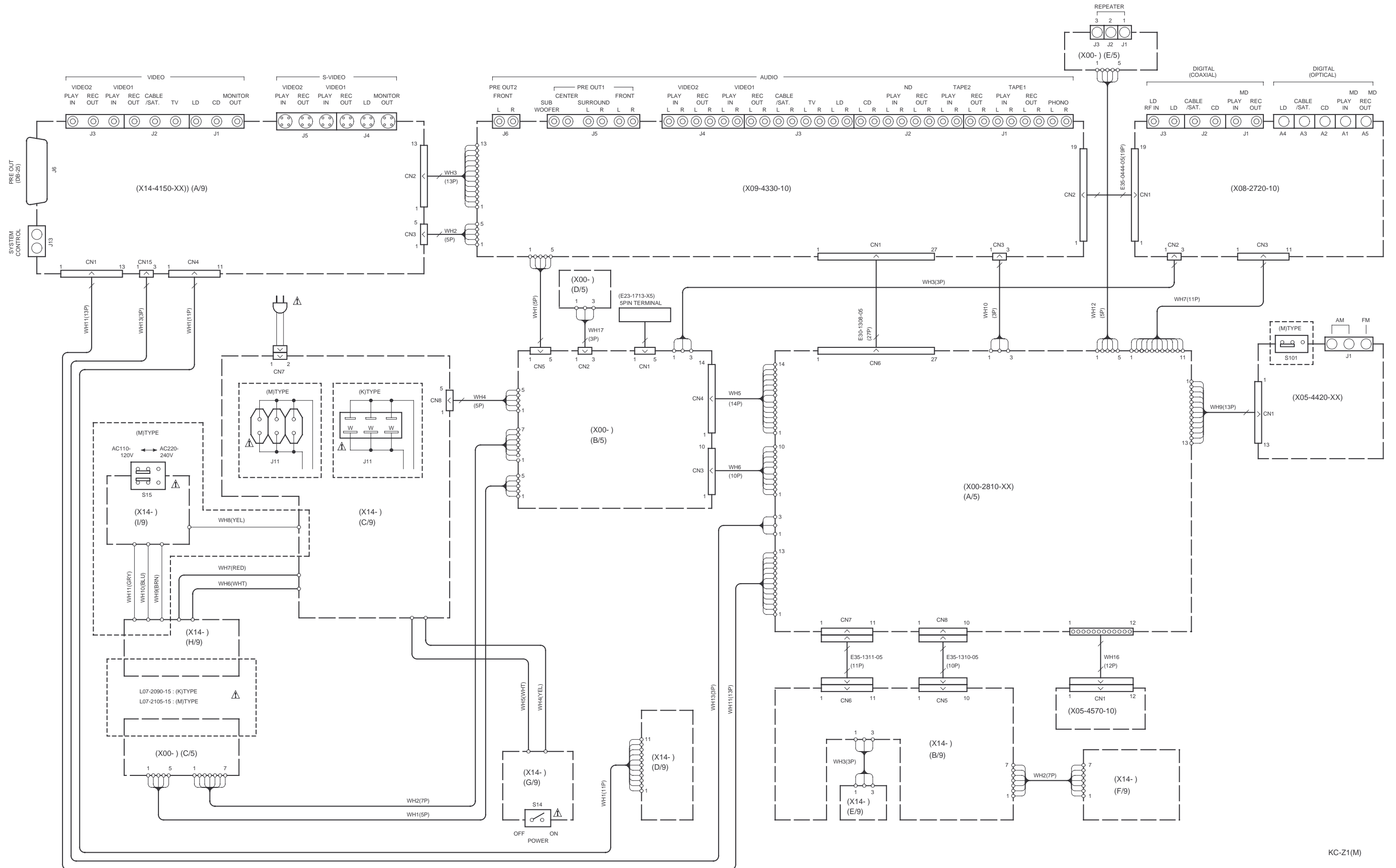

PC BOARD (Component side view)

POWER SUPPLY UNIT (X00-2810-XX)

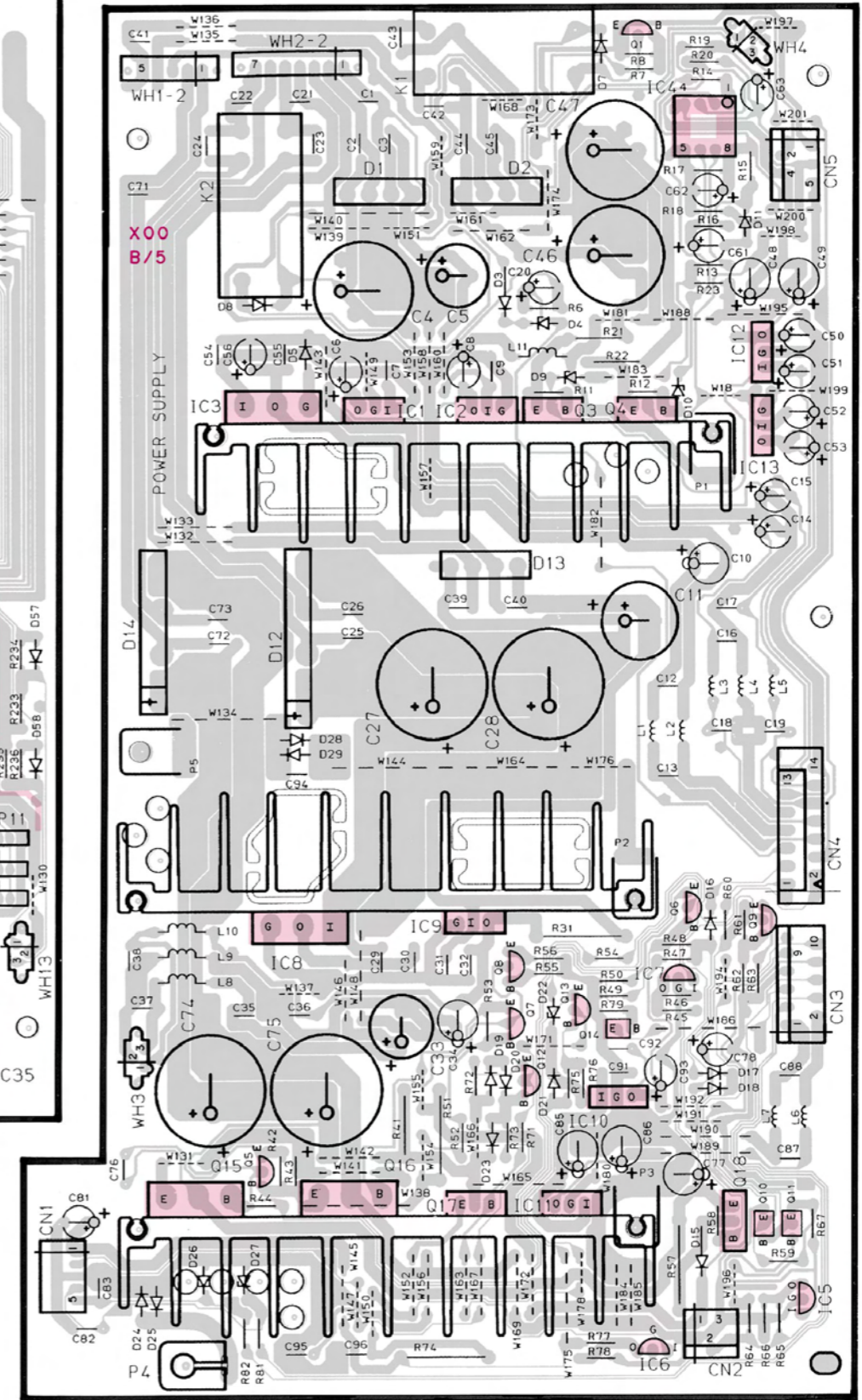
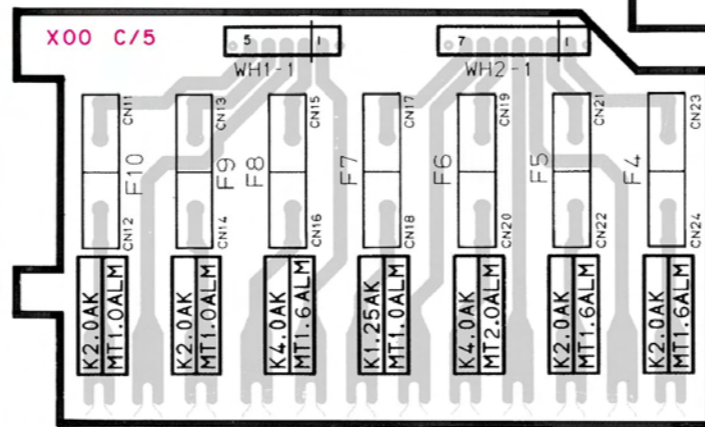
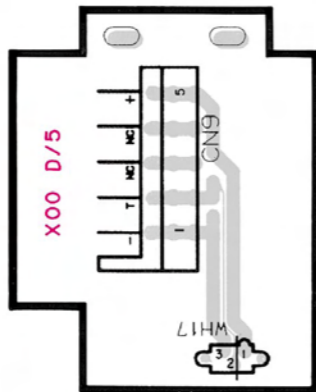
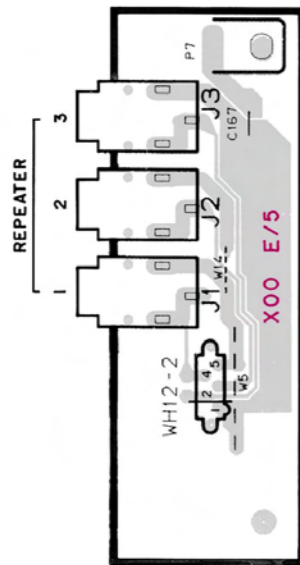
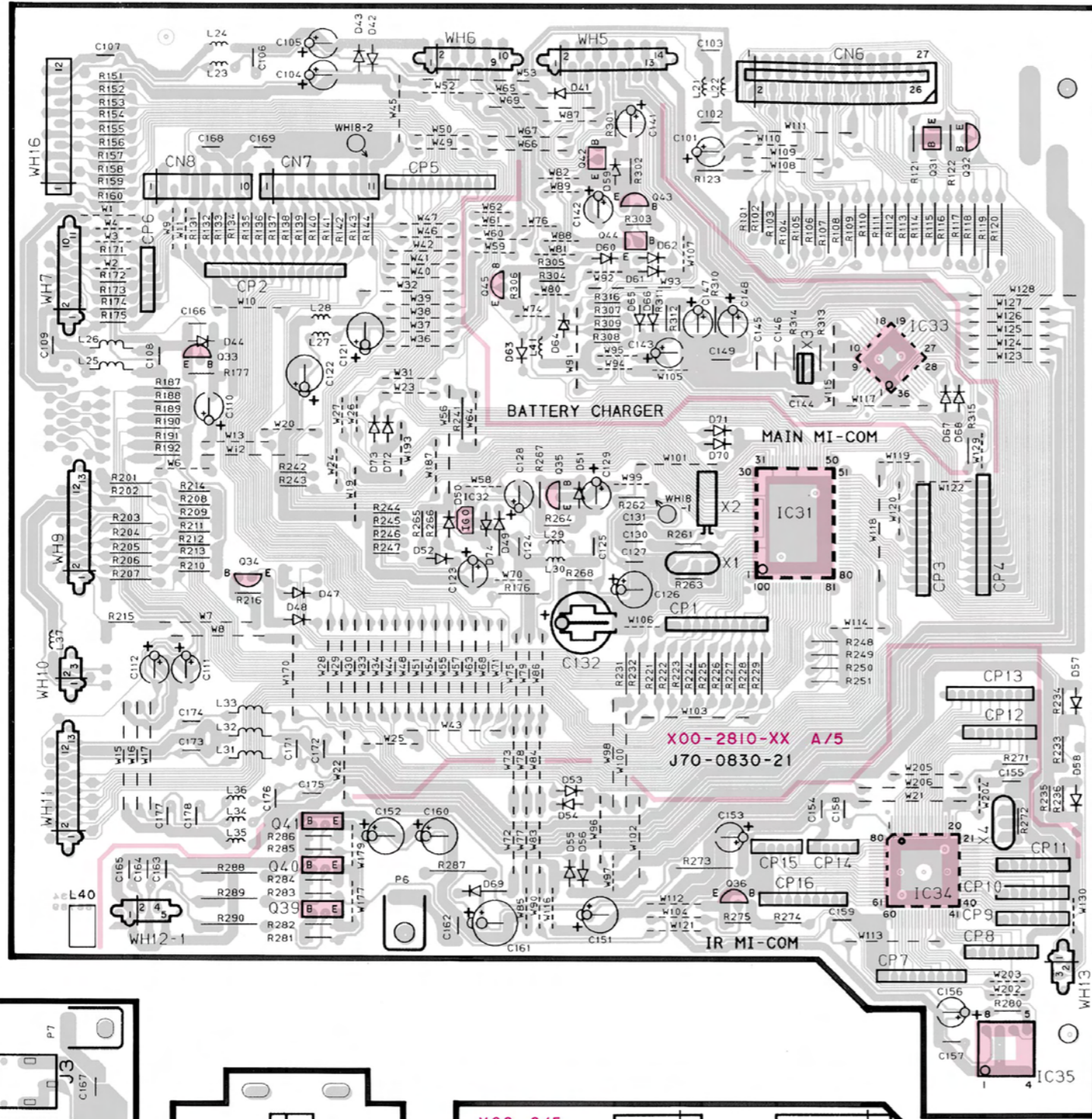

Refer to the schematic diagram for the values of resistors and capacitors.

PC BOARD (Component side view) SURROUND UNIT (X08-2720-10)

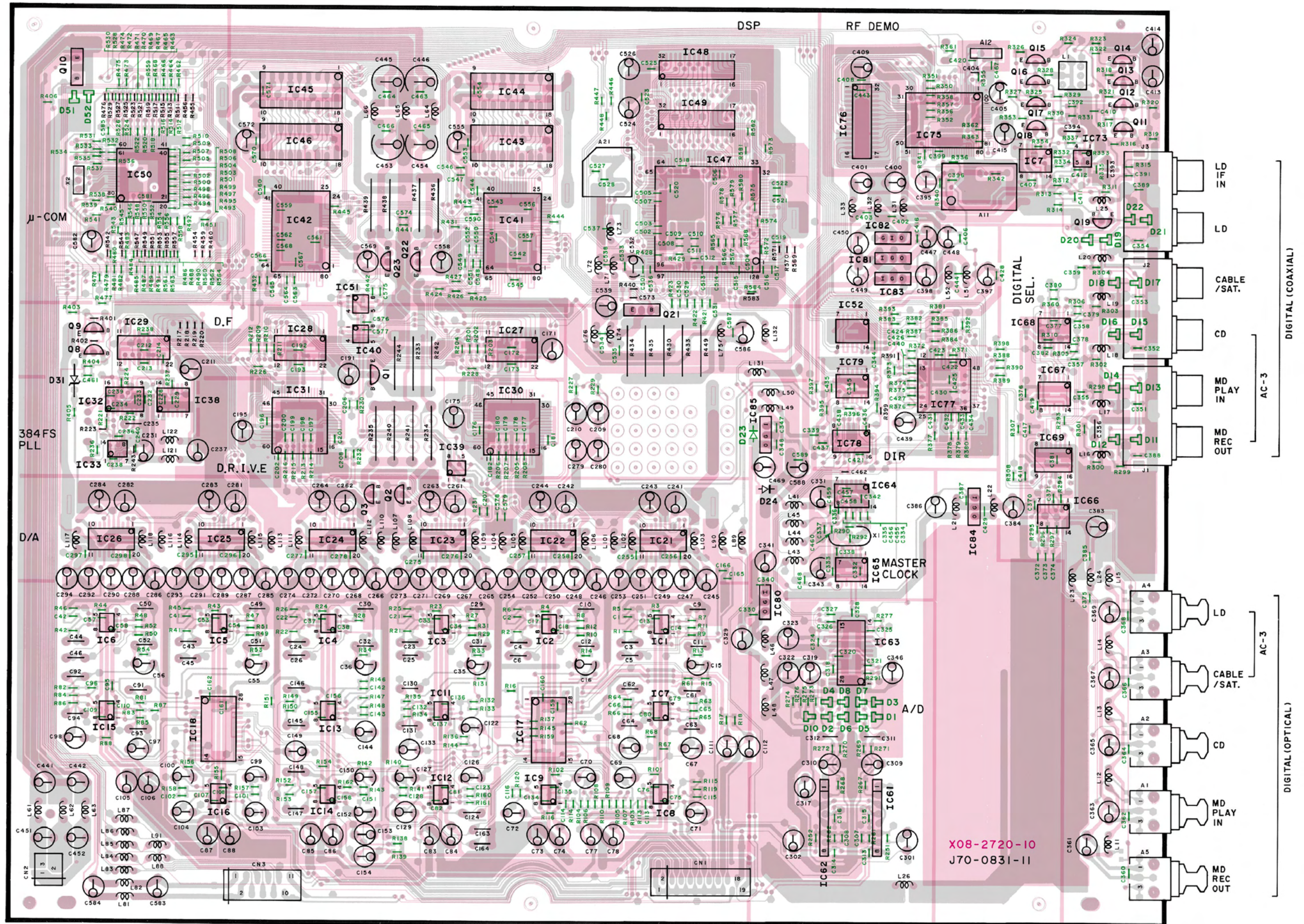

PC BOARD (Component side view)

AUDIO UNIT (X09-4330-10)

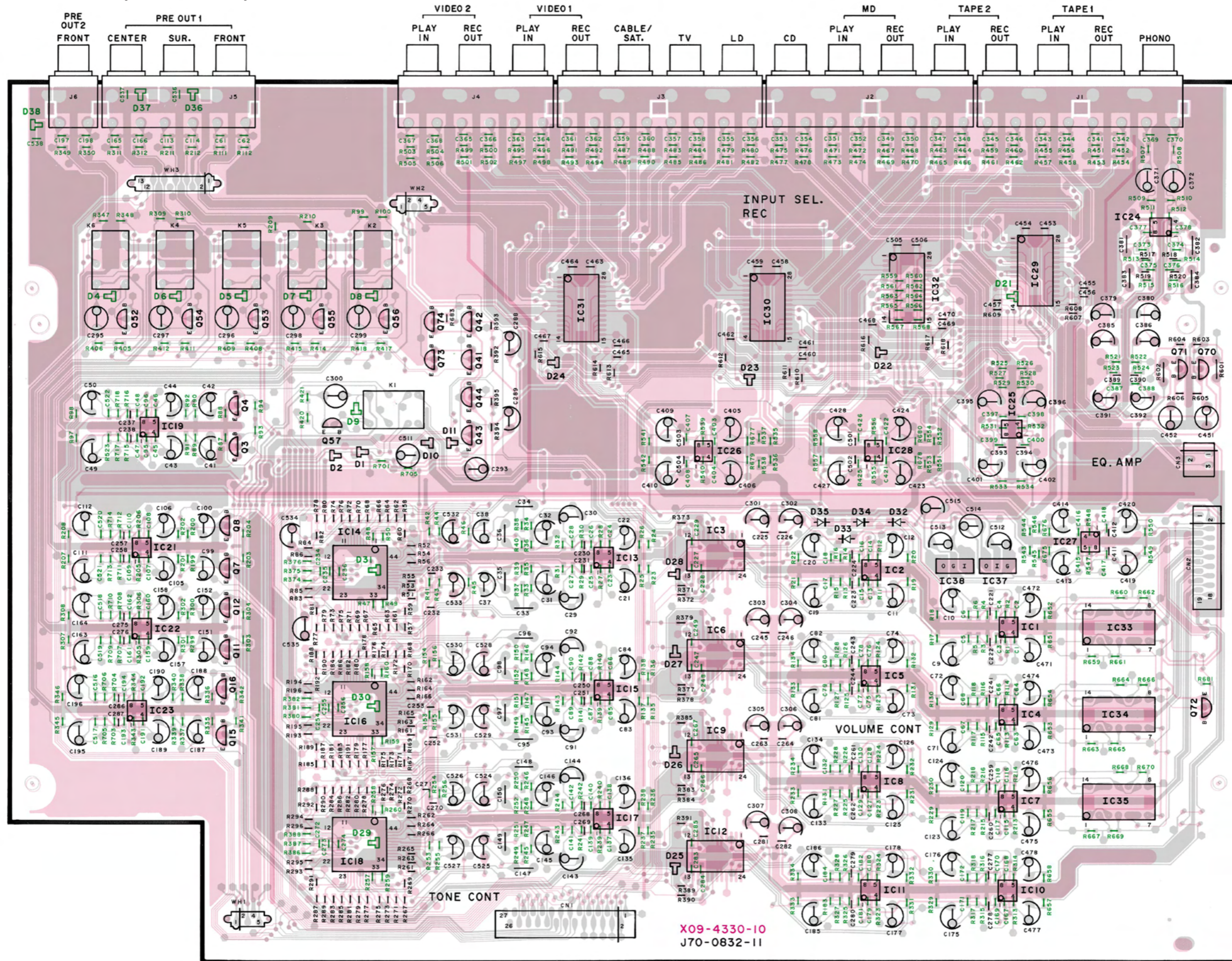

Refer to the schematic diagram for the values of resistors and capacitors.

PC BOARD (Component side view)

DISPLAY UNIT (X14-4150-XX)

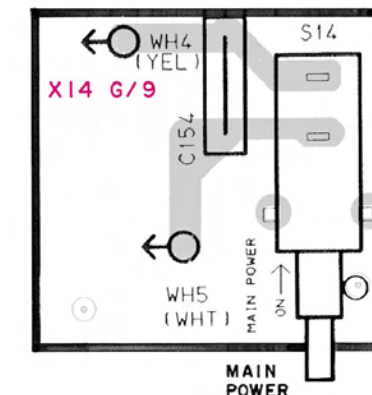
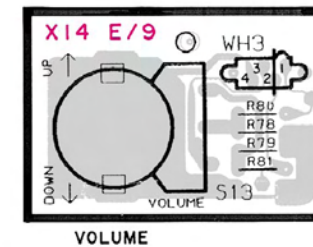
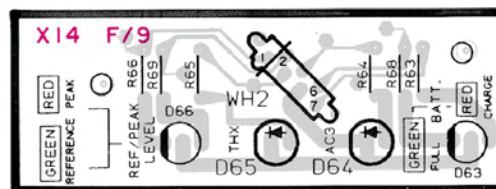
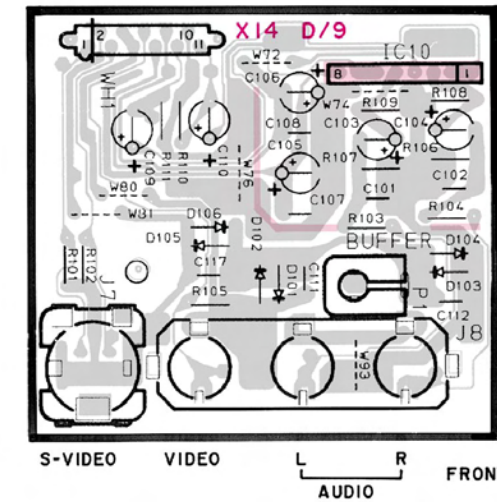
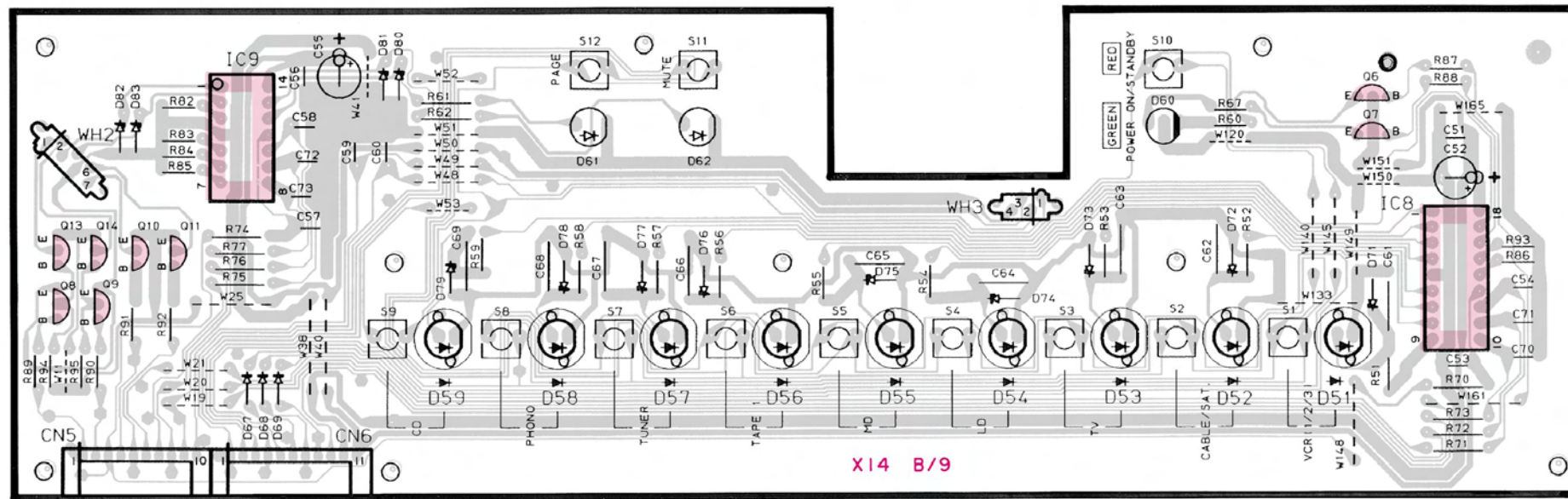
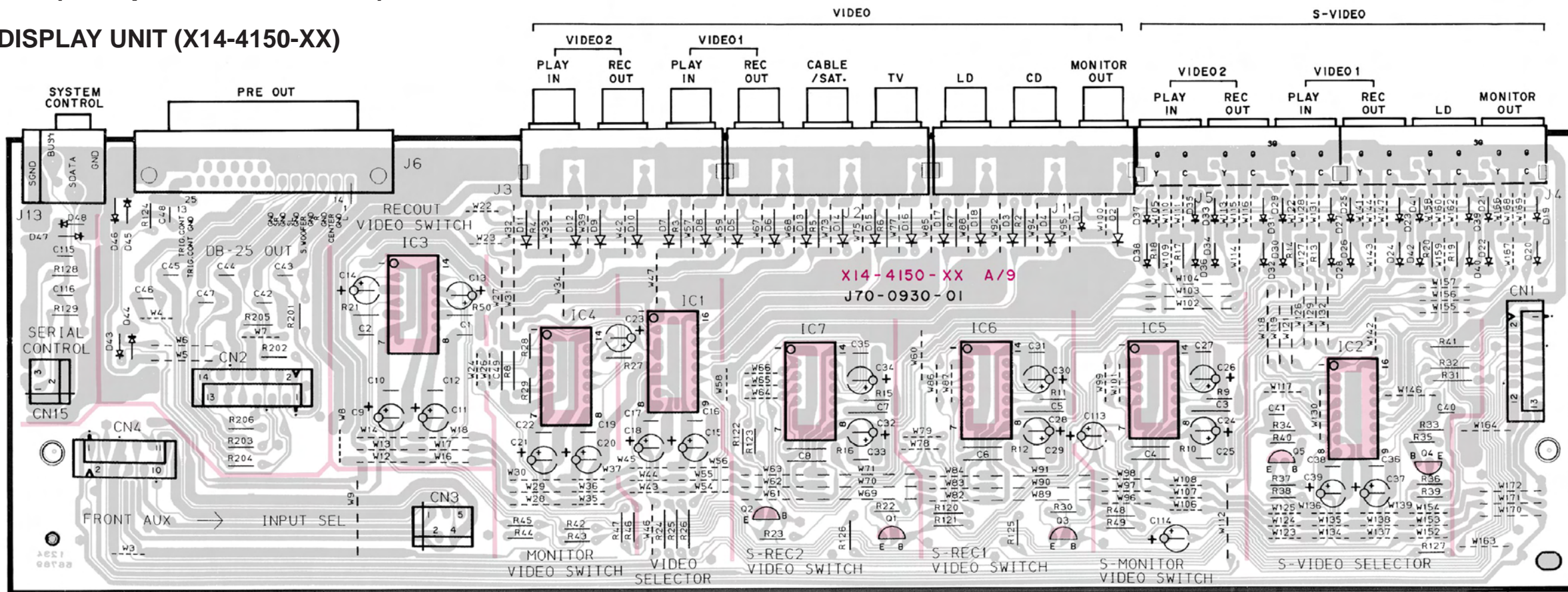

PC BOARD (Component side view)

DISPLAY UNIT (X14-4150-XX)

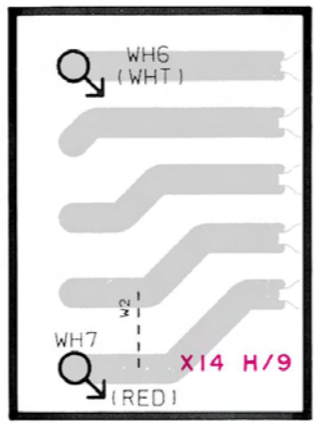
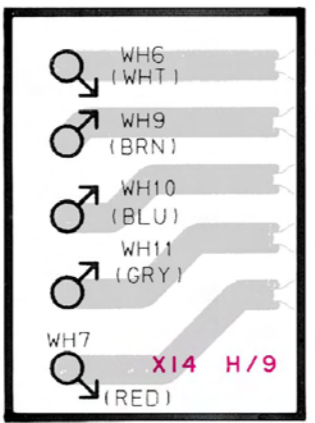
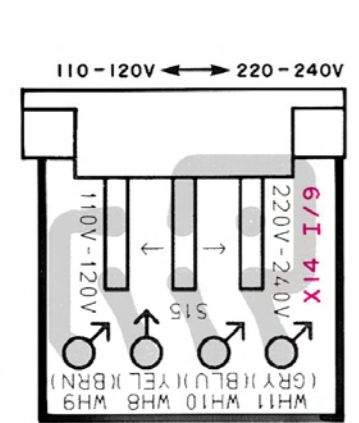
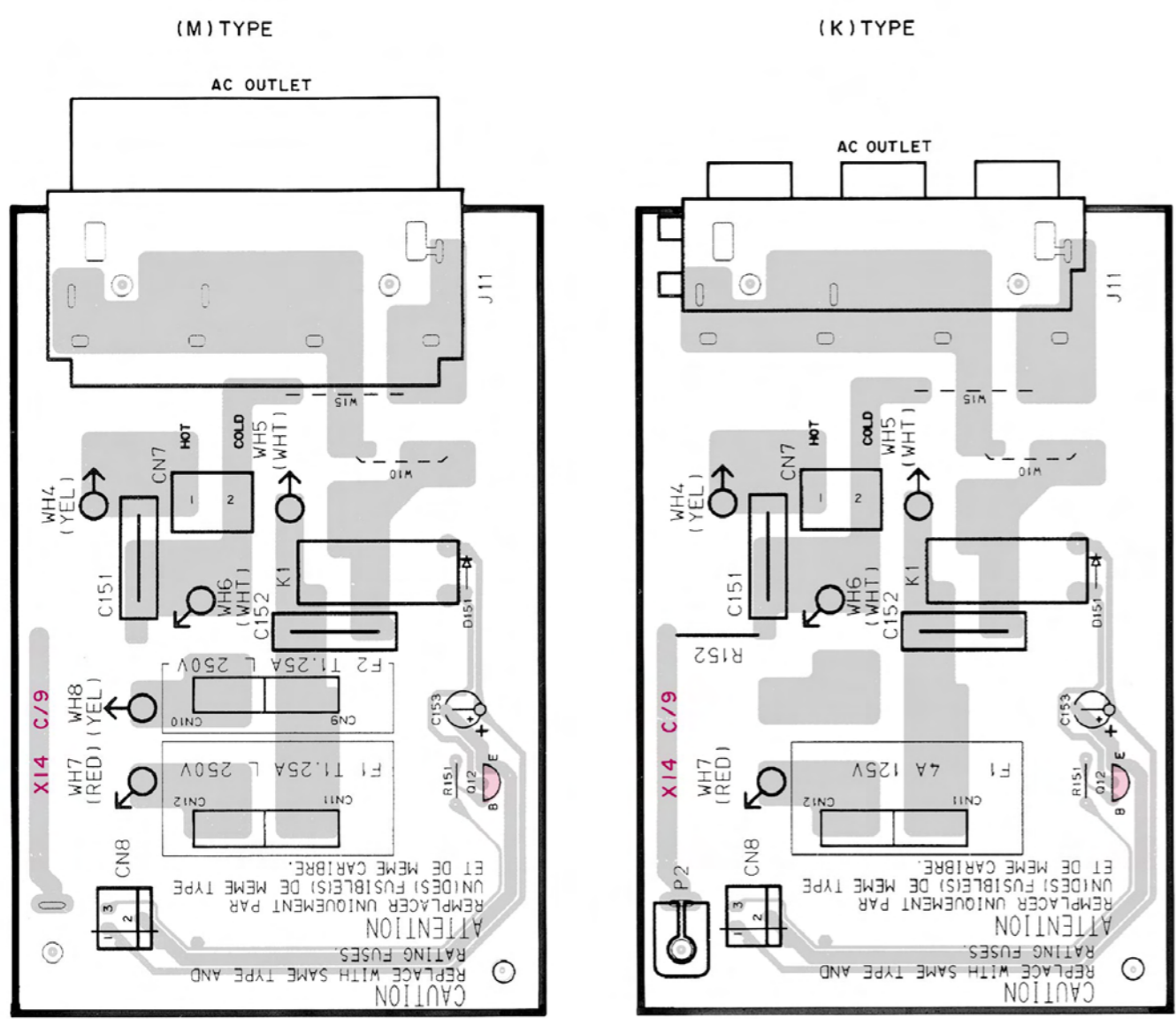

TUNER UNIT (X05-4420-XX) : K,M

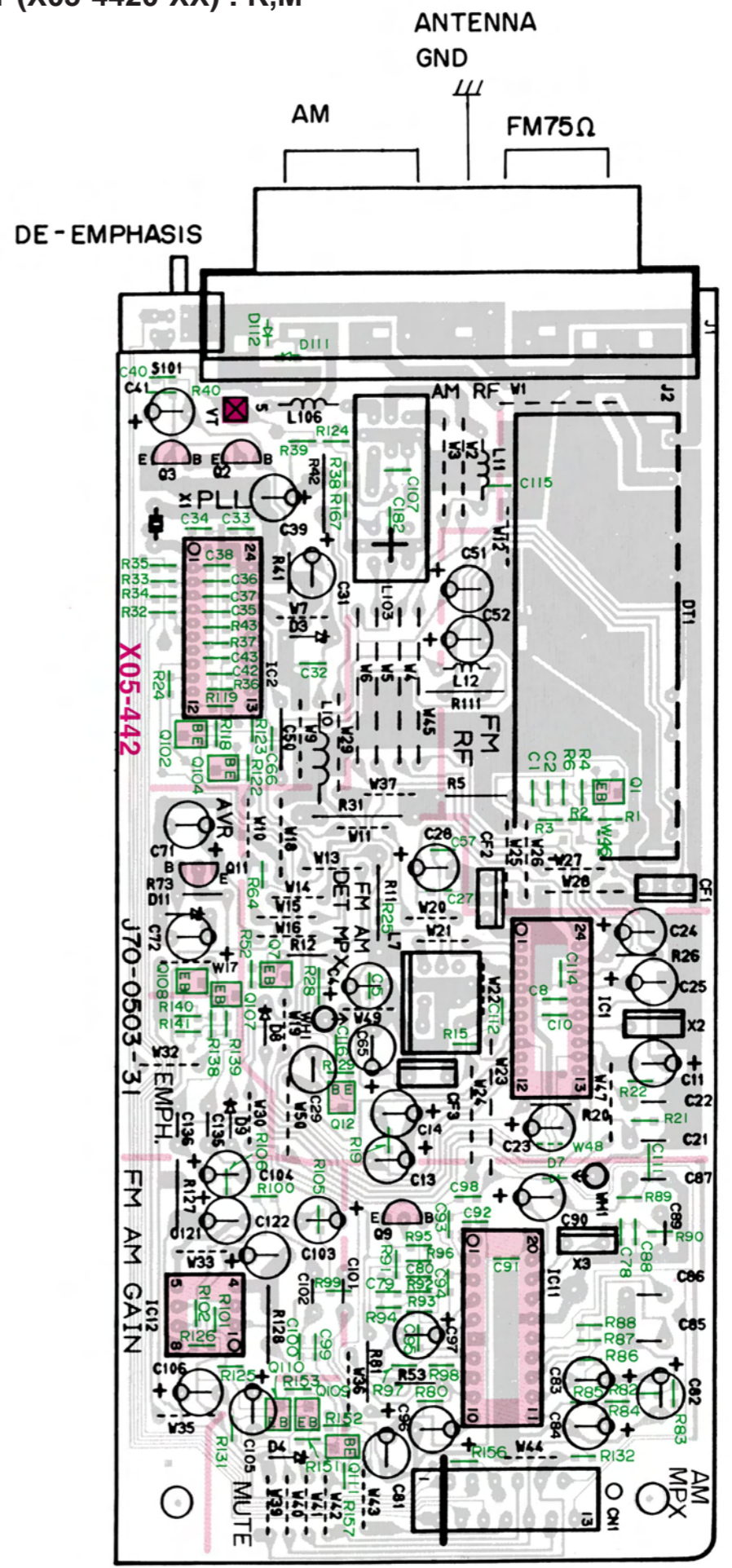

Refer to the schematic diagram for the values of resistors and capacitors.

PC BOARD (Component side view)

REMOTE CONTROL RECEIVE/TRANSMIT UNIT (X05-4570-10)

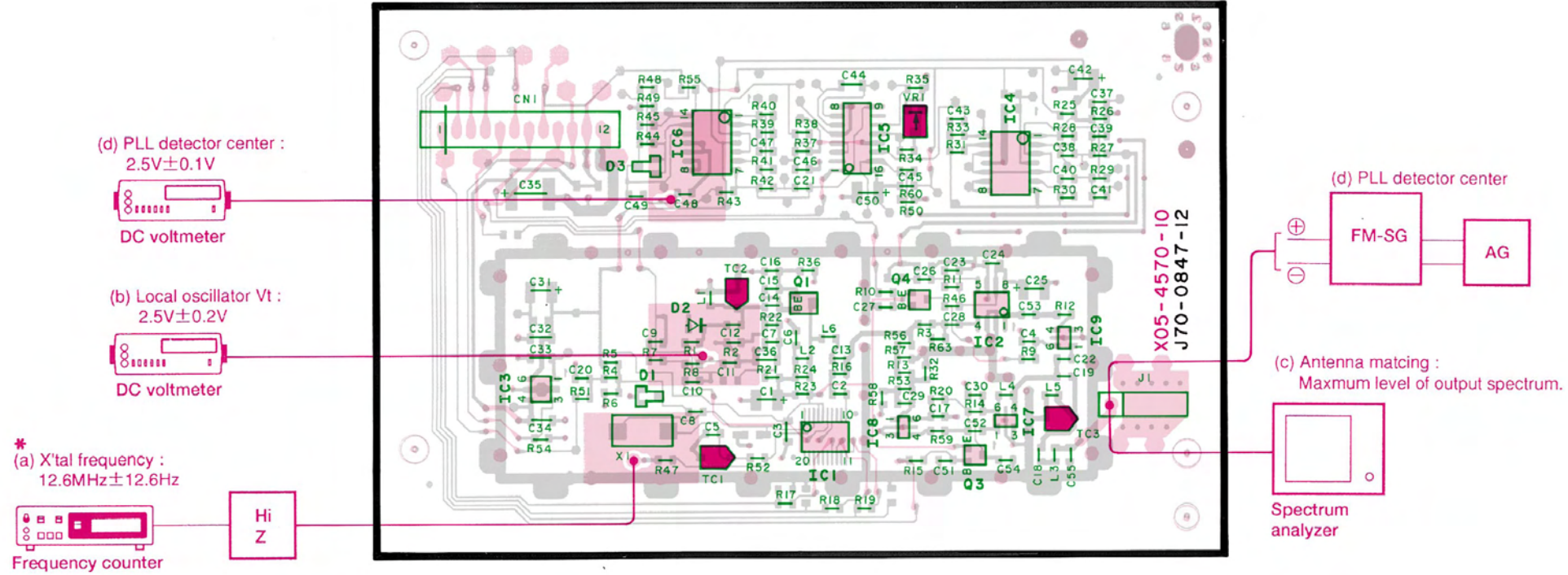

LCD REMOTE CONTROLLER UNIT (X25-5690-10)

[Remove the black battery board, then see the check round]

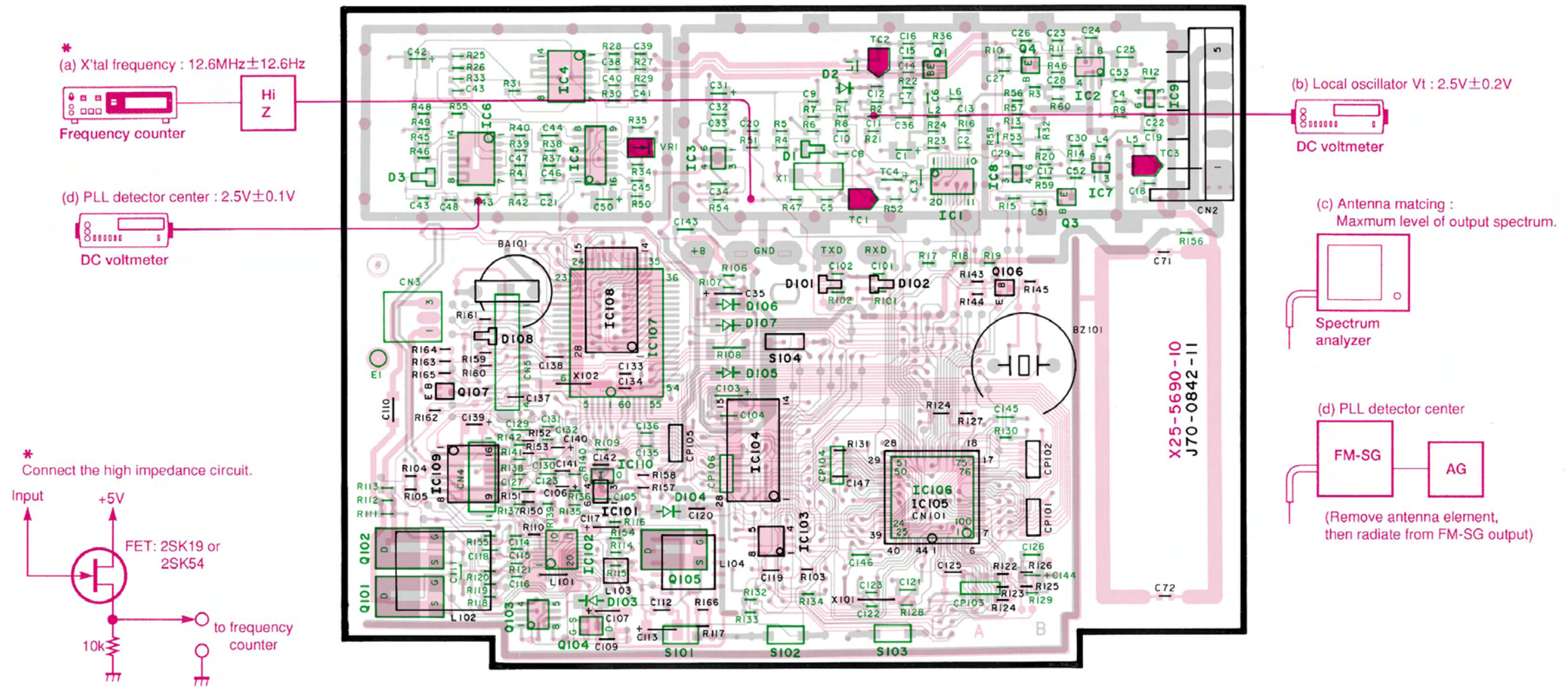

The DC voltage is an actual reading measured with a high impedance type voltmeter as the AM/FM signal generator is specified to the conditions as shown in the list right. The measurement value may vary depending on the measuring instruments used or on the product. The value shown in () is actual reading measured in the AM mode.

MODE	CARRIER	MODULATION		ANT INPUT
		FREQUENCY	DEVIATION	
FM	98MHz	1KHz	STEREO 67.5KHz 7.5KHz(Pilot)	60dB
AM	1000(999)KHz	400Hz	MONO 30% MOD	60dB

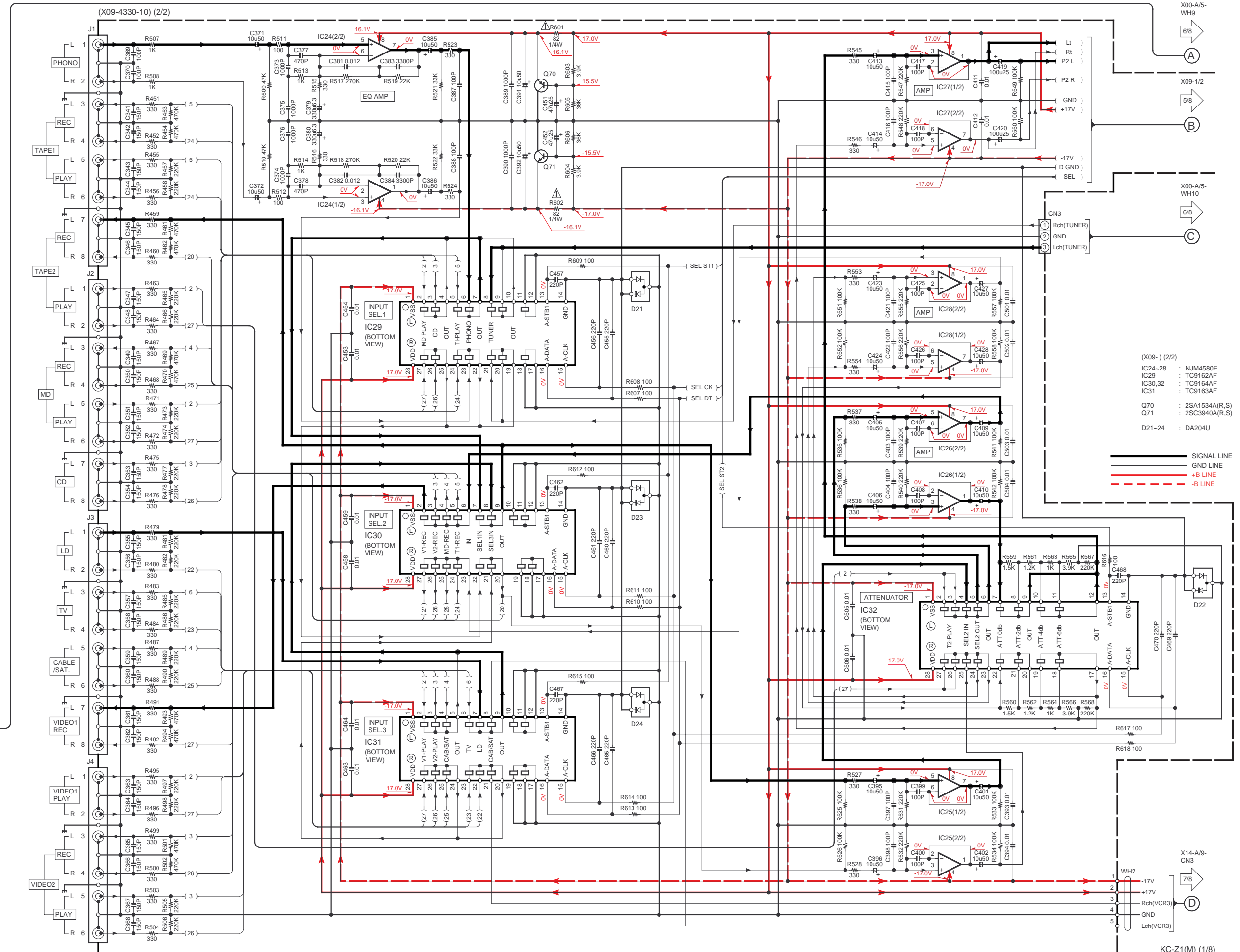
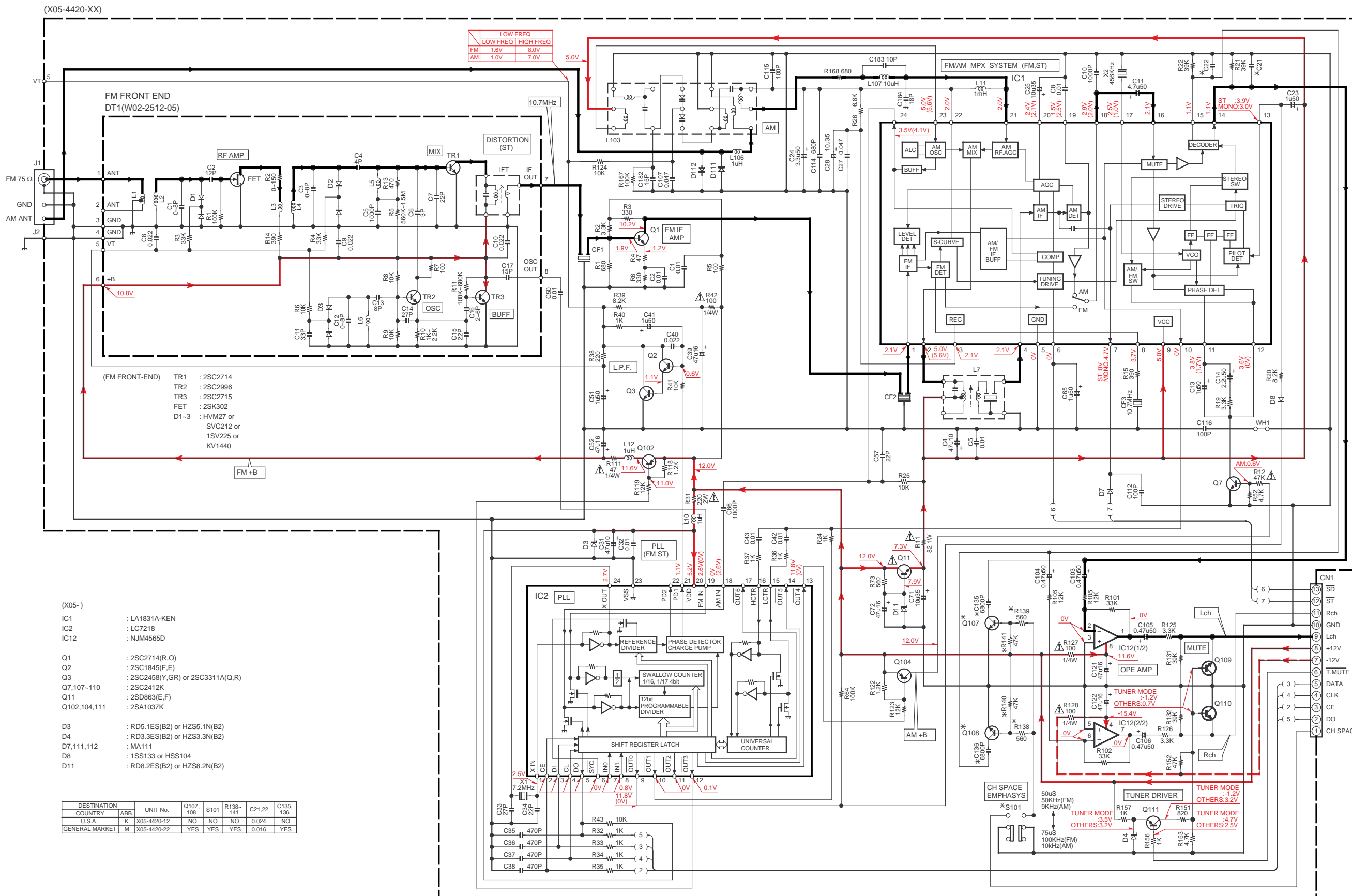

CAUTION: For continued safety, replace safety critical components only with manufacturer's recommended parts (refer to parts list). **A** indicates safety critical components. For continued protection against risk of fire, replace only with same type and rating fuse(s). To reduce the risk of electric shock, leakage-current or resistance measurements shall be carried out (exposed parts are acceptably insulated from the supply circuit) before the appliance is returned to the customer.

The DC voltage is an actual reading measured with a high impedance type voltmeter with no signal input. The measurement value may vary depending on the measuring instruments used or on the product.

DOLBY and the double-D symbol are trademarks of Dolby Laboratories Licensing Corporation. Noise reduction circuit made under license from Dolby Laboratories Licensing Corporation.

- 2SA1534A
- 2SA992
- 2SC1845
- 2SC1923
- 2SC2003
- 2SC2878
- 2SC3940A
- 2SD863
- 2SB772
- 2SD882

- DTA124ES
- DTC124ES
- DTC143TS
- UN4112
- 2SC2458
- 2SA1037K
- 2SA1576
- 2SC2412K
- 2SC2714
- 2SC3547A

- 2SB1370
- 2SD2061
- UN4212
- UN4216
- UN4219
- 2SC3311A
- 2SB1375
- 2SB1587
- 2SD2012

- NJM4565D
- NJM4580E
- NJM2279D
- TC4051BP
- TC4052BP

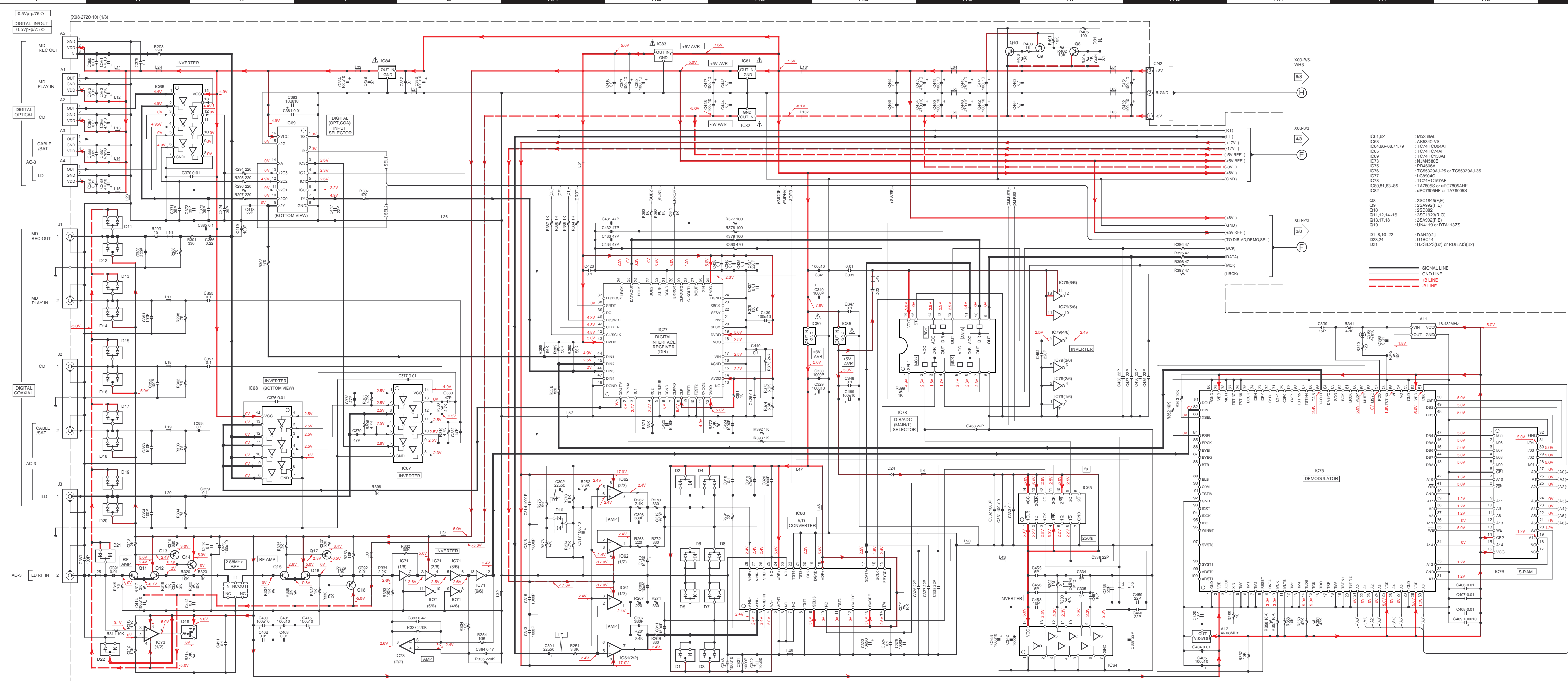

0.5Vp-p/75Ω
DIGITAL IN/OUT
0.5Vp-p/75Ω

IC61,62 : M5238AL
IC63 : AK5340-VS
IC65 : TC74HC00AF
IC66 : TC74HC74AF
IC69 : TC74HC153AF
IC73 : NJM4580-D
IC75 : PD4606A
IC76 : TC5532PAJ-25 or TC5532PAJ-35
IC77 : LC5946D
IC78 : TC74HC157AF
IC80,81,83-85 : TA7805S or μPC7805AHF
IC82 : μPC7805HF or TA7805SS
Q8 : 2SC1845(F,E)
Q9 : 2SA992(F,E)
Q10 : 2SD862
Q11,12,14-16 : 2SC1923(R,O)
Q13,17,18 : 2SA992(F,E)
Q19 : UM4119 or OTA1132S
D1-8,10-22 : DAN202U
D23,24 : U18C44
D31 : H258,25(B2) or RDB,2J5(B2)

— SIGNAL LINE
- - - +5V
· · · -5V

IC79(6) : 2SC1845(F,E)
IC79(5) : 2SA992(F,E)
IC79(4) : 2SC1923(R,O)
IC79(3) : 2SC1845(F,E)
IC79(2) : 2SA992(F,E)
IC79(1) : 2SC1923(R,O)

IC76 : DIR/ADC (MAIN/T) SELECTOR
IC77 : DIGITAL INTERFACE RECEIVER (DIR)
IC78 : DAC
IC79 : AMP

IC62 : 2SC1845(F,E)
IC63 : AK5340-VS
IC65 : TC74HC00AF
IC66 : TC74HC74AF
IC69 : TC74HC153AF
IC73 : NJM4580-D
IC75 : PD4606A
IC76 : TC5532PAJ-25 or TC5532PAJ-35
IC77 : LC5946D
IC78 : TC74HC157AF
IC80,81,83-85 : TA7805S or μPC7805AHF
IC82 : μPC7805HF or TA7805SS

Q8 : 2SC1845(F,E)
Q9 : 2SA992(F,E)
Q10 : 2SD862
Q11,12,14-16 : 2SC1923(R,O)
Q13,17,18 : 2SA992(F,E)
Q19 : UM4119 or OTA1132S
D1-8,10-22 : DAN202U
D23,24 : U18C44
D31 : H258,25(B2) or RDB,2J5(B2)

IC61,62 : M5238AL
IC63 : AK5340-VS
IC65 : TC74HC00AF
IC66 : TC74HC74AF
IC69 : TC74HC153AF
IC73 : NJM4580-D
IC75 : PD4606A
IC76 : TC5532PAJ-25 or TC5532PAJ-35
IC77 : LC5946D
IC78 : TC74HC157AF
IC80,81,83-85 : TA7805S or μPC7805AHF
IC82 : μPC7805HF or TA7805SS
Q8 : 2SC1845(F,E)
Q9 : 2SA992(F,E)
Q10 : 2SD862
Q11,12,14-16 : 2SC1923(R,O)
Q13,17,18 : 2SA992(F,E)
Q19 : UM4119 or OTA1132S
D1-8,10-22 : DAN202U
D23,24 : U18C44
D31 : H258,25(B2) or RDB,2J5(B2)

KC-Z1(M) (2/8)

CAUTION: For continued safety, replace safety critical components only with manufacturer's recommended parts (refer to parts list). ⚠ indicates safety critical components. For continued protection against risk of fire, replace only with same type and rating fuse(s). To reduce the risk of electric shock, leakage-current or resistance measurements shall be carried out (exposed parts are acceptably insulated from the supply circuit) before the appliance is returned to the customer.

The DC voltage is an actual reading measured with a high impedance type voltmeter with no signal input. The measurement value may vary depending on the measuring instruments used or on the product.

DOLBY and the double-D symbol are trademarks of Dolby Laboratories Licensing Corporation. Noise reduction circuit made under license from Dolby Laboratories Licensing Corporation.

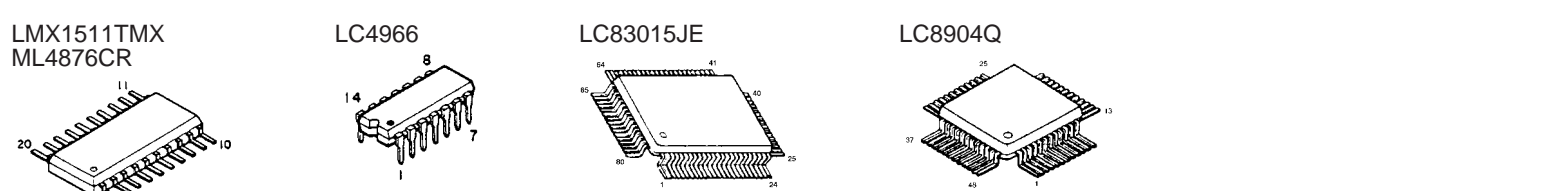
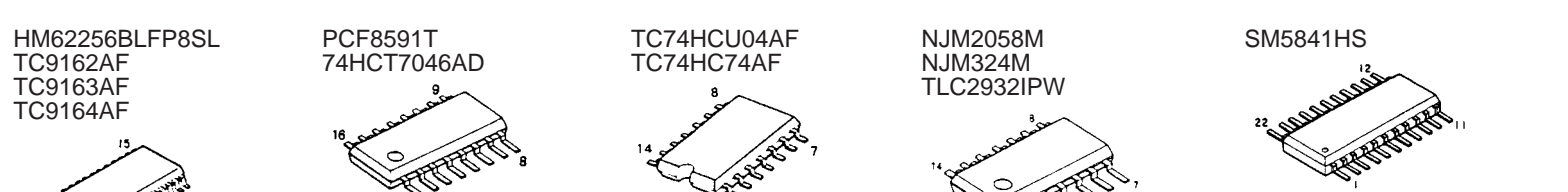
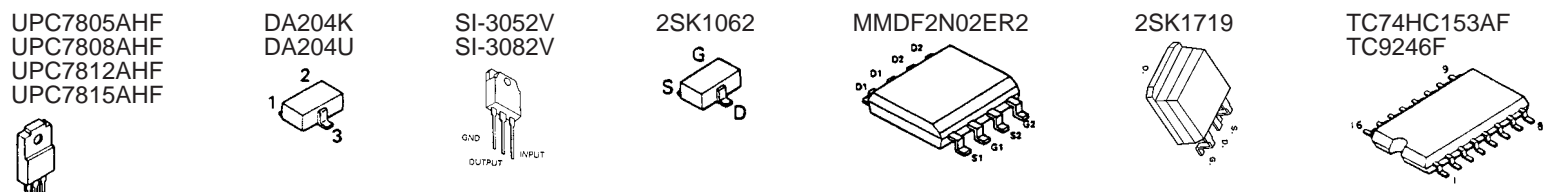
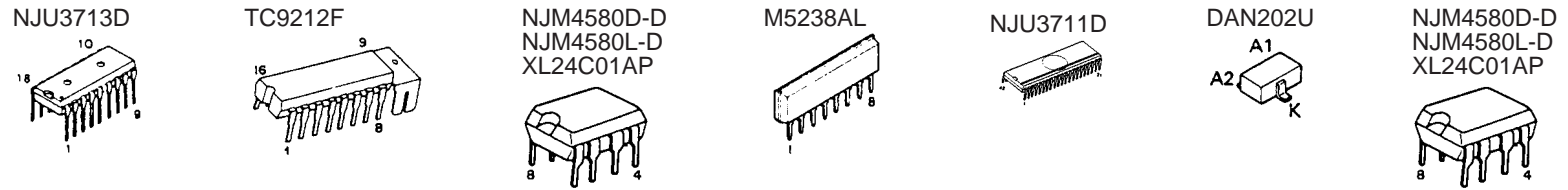

KC-Z1/RC-Z1
KENWOOD

Y05-3140-10

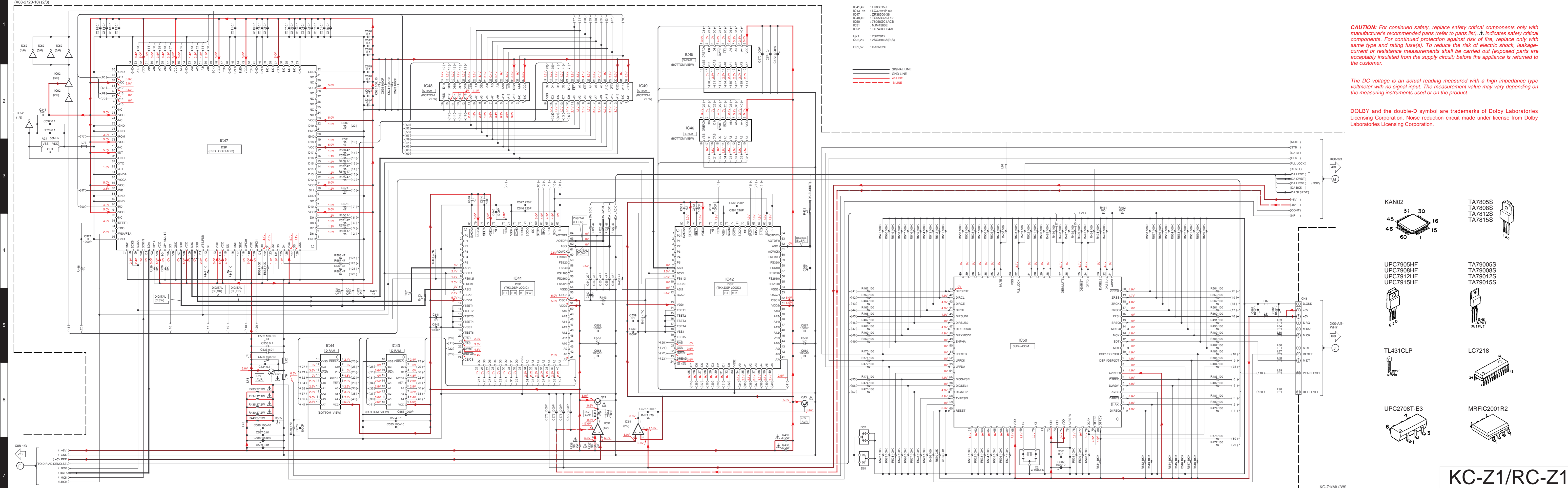

CAUTION: For continued safety, replace safety critical components only with manufacturer's recommended parts (refer to parts list). ⚠ indicates safety critical components. For continued protection against risk of fire, replace only with same type and rating fuse(s). To reduce the risk of electric shock, leakage-current or resistance measurements shall be carried out (exposed parts are acceptably insulated from the supply circuit) before the appliance is returned to the customer.

The DC voltage is an actual reading measured with a high impedance type voltmeter with no signal input. The measurement value may vary depending on the measuring instruments used or on the product.

DOLBY and the double-D symbol are trademarks of Dolby Laboratories Licensing Corporation. Noise reduction circuit made under license from Dolby Laboratories Licensing Corporation.

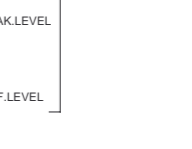
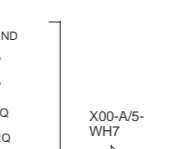
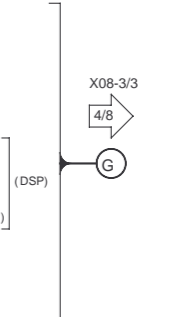
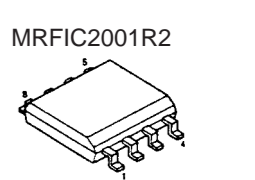
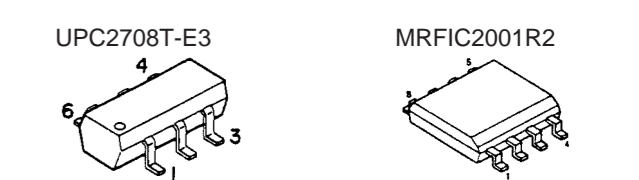
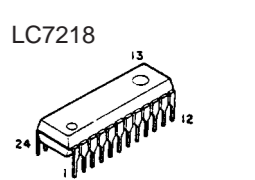
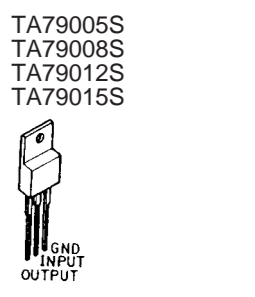
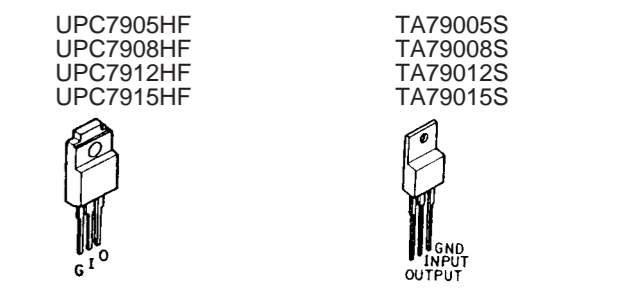
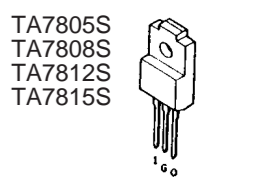
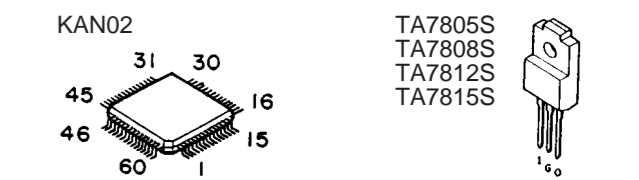

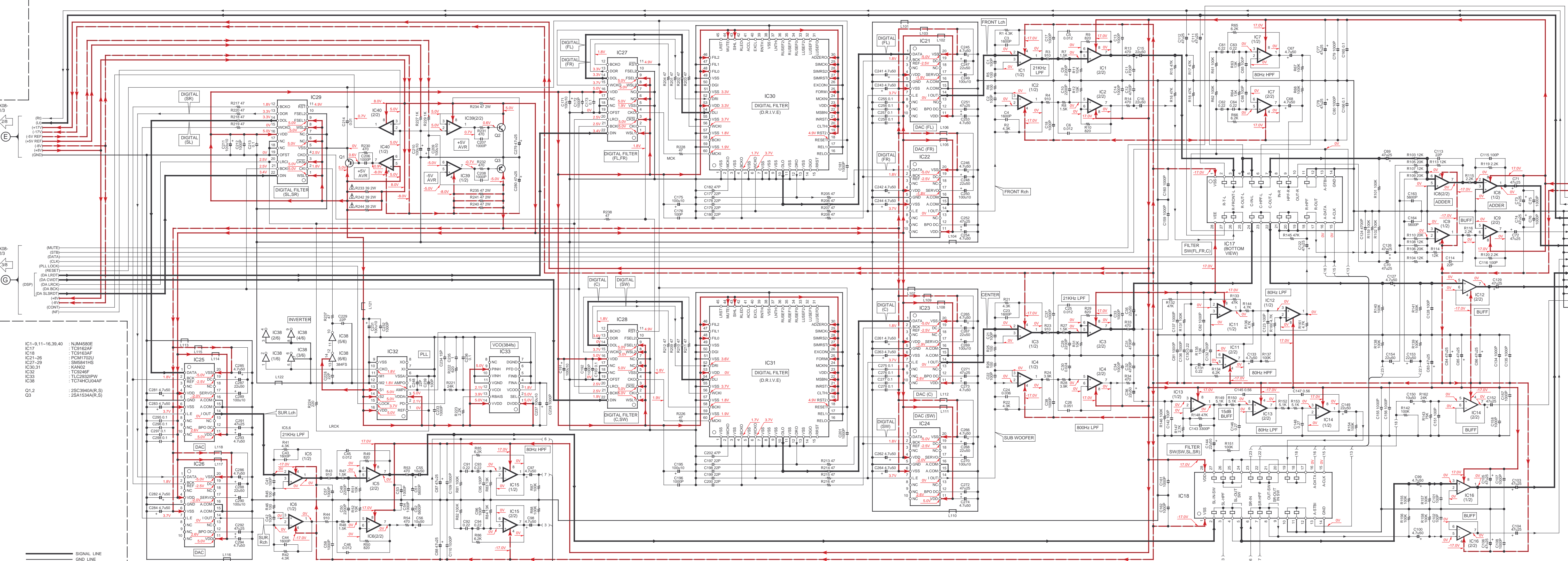

- IC1-9,11-16,39,40 : NJM4580E
- IC17 : TC9162AF
- IC18 : TC9163AF
- IC21-26 : PCM1702J
- IC27-29 : SM5841HS
- IC30,31 : KAN02
- IC32 : TC9246F
- IC33 : TLC2932IPW
- IC38 : TC74HC04AF
- Q1,2 : 2SC3940A(R,S)
- Q3 : 2SA1534A(R,S)



CAUTION: For continued safety, replace safety critical components only with manufacturer's recommended parts (refer to parts list). ⚠ indicates safety critical components. For continued protection against risk of fire, replace only with same type and rating value(s). To reduce the risk of electric shock, leakage-current or resistance measurements shall be carried out (exposed parts are acceptably insulated from the supply circuit) before the appliance is returned to the customer.

The DC voltage is an actual reading measured with a high impedance type voltmeter with no signal input. The measurement value may vary depending on the measuring instruments used or on the product.

DOLBY and the double-D symbol are trademarks of Dolby Laboratories Licensing Corporation. Noise reduction circuit made under license from Dolby Laboratories Licensing Corporation.

- X09-12-01 CN2
- SC401737FU
- MM1134BFFE
- TC74HC157AF
- PD4606A
- TK11250AU
- SED1330FBA
- TC55329AJ-25
- TC55329AJ-35
- DCC5555A/22
- 27C40961AAA

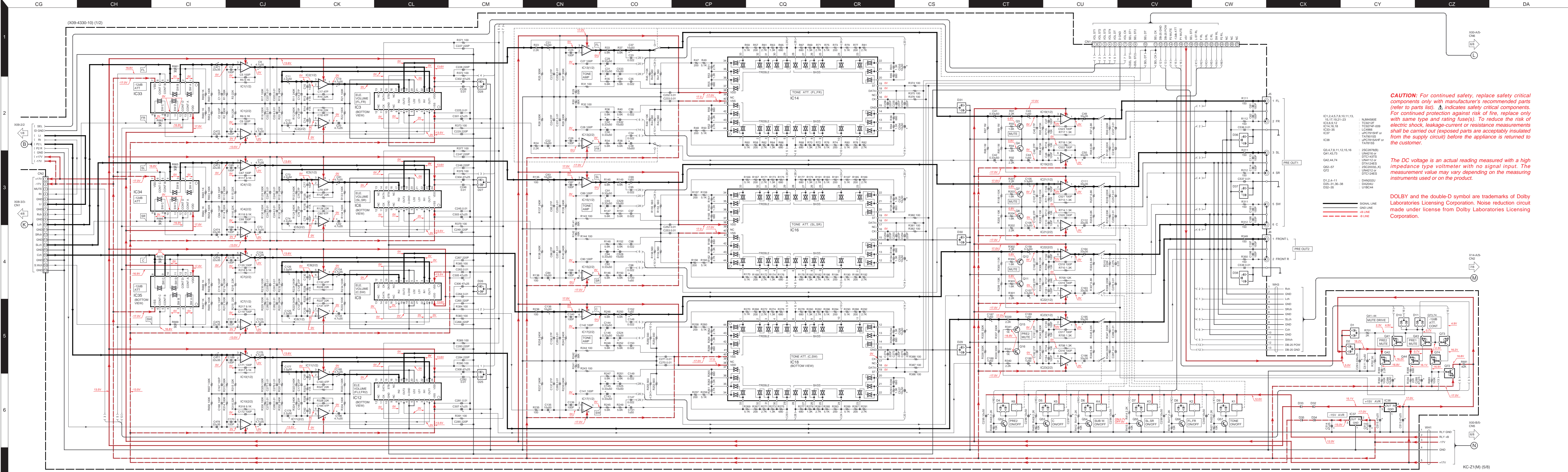

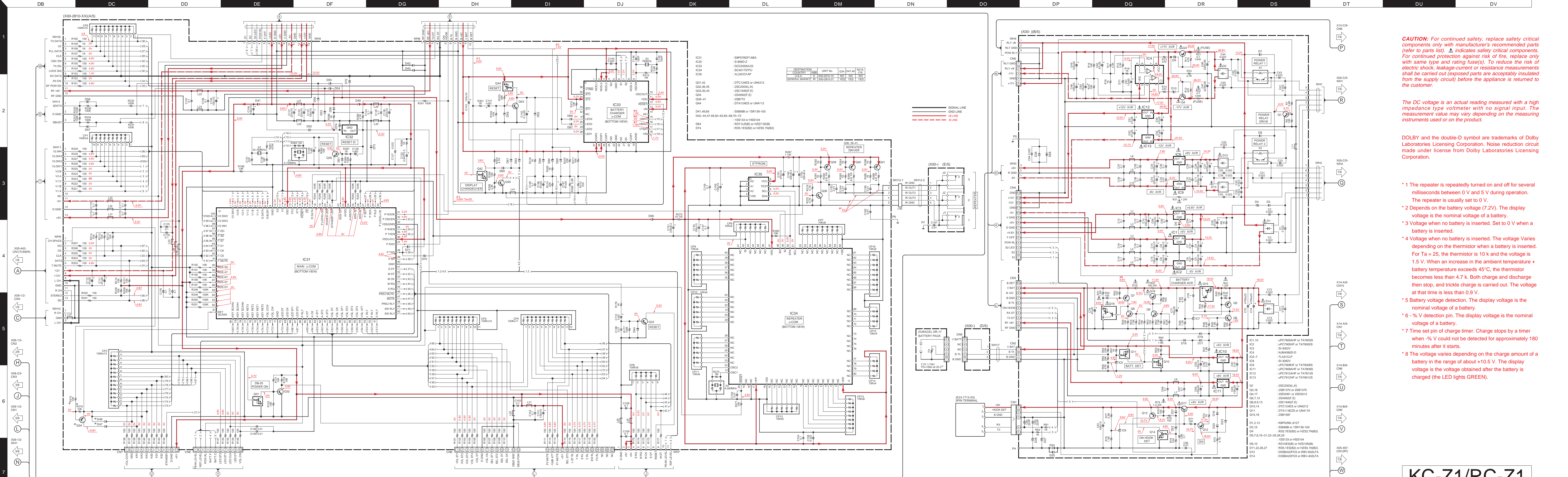

CAUTION: For continued safety, replace safety critical components only with manufacturer's recommended parts (refer to parts list). Δ indicates safety critical components. For continued protection against risk of fire, replace only with same type and rating fuse(s). To reduce the risk of electric shock, leakage-current or resistance measurements shall be carried out (exposed parts are acceptably insulated from the supply circuit) before the appliance is returned to the customer.

The DC voltage is an actual reading measured with a high impedance type voltmeter with no signal input. The measurement value may vary depending on the measuring instruments used or on the product.

DOLBY B and the double-D symbol are trademarks of Dolby Laboratories Licensing Corporation. Noise reduction circuit made under license from Dolby Laboratories Licensing Corporation.

- * 1 The repeater is repeatedly turned on and off for several milliseconds between 0 V and 5 V during operation. The repeater is usually set to 0 V.
- * 2 Depends on the battery voltage (7.2V). The display voltage is the nominal voltage of a battery.
- * 3 Voltage when no battery is inserted. Set to 0 V when a battery is inserted.
- * 4 Voltage when no battery is inserted. The voltage varies depending on the thermistor when a battery is inserted. For $T_a = 25$, the thermistor is 10 k and the voltage is 1.5 V. When an increase in the ambient temperature + battery temperature exceeds 45°C, the thermistor becomes less than 4.7 k. Both charge and discharge then stop, and trickle charge is carried out. The voltage at that time is less than 0.9 V.
- * 5 Battery voltage detection. The display voltage is the nominal voltage of a battery.
- * 6 - % V detection pin. The display voltage is the nominal voltage of a battery.
- * 7 Time set pin of charge timer. Charge stops by a timer when -% V could not be detected for approximately 180 minutes after it starts.
- * 8 The voltage varies depending on the charge amount of a battery in the range of about +10.5 V. The display voltage is the voltage obtained after the battery is charged (the LED lights GREEN).

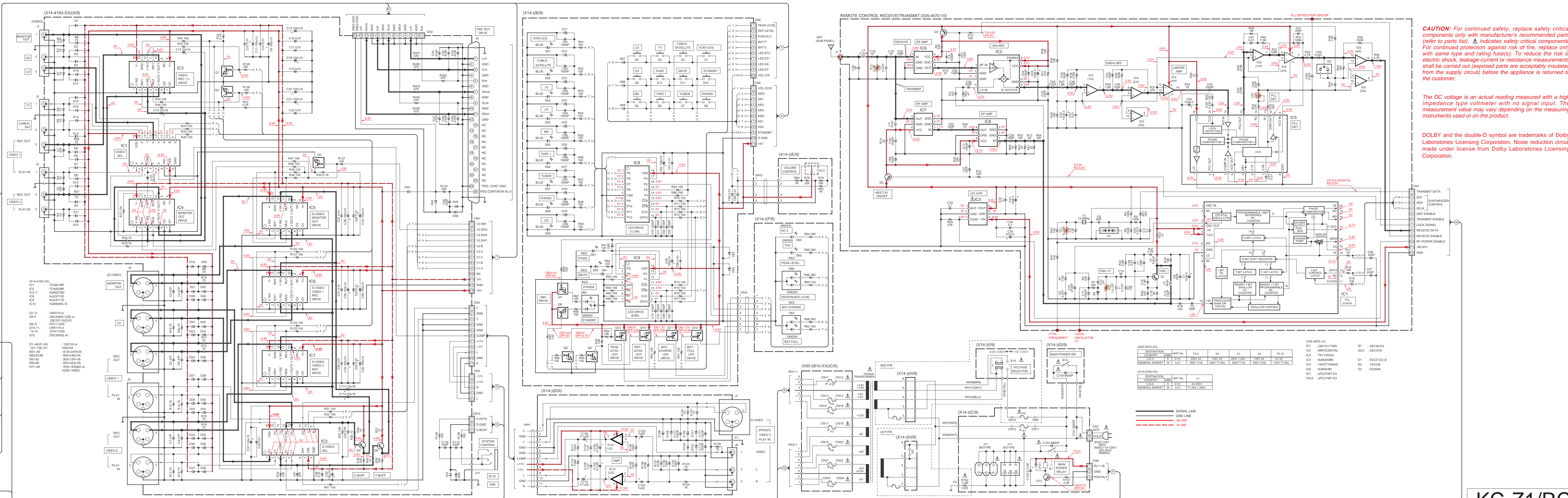

CAUTION: For continued safety, replace safety critical components only with manufacturer's recommended parts (refer to parts list). **▲** indicates safety critical components. For continued protection against risk of fire, replace only with same type and rating fuse(s). To reduce the risk of electric shock, leakage-current or resistance measurements shall be carried out (exposed parts are acceptably insulated from the supply circuit) before the appliance is returned to the customer.

The DC voltage is an actual reading measured with a high impedance type voltmeter with no signal input. The measurement value may vary depending on the measuring instruments used or on the product.

DOLBY B and the double-D symbol are trademarks of Dolby Laboratories Licensing Corporation. Noise reduction circuit made under license from Dolby Laboratories Licensing Corporation.

- (X14-4150-XX)
- IC1 : TCA6818P
 - IC2 : TCA628P
 - IC3-7 : NJM279D
 - IC8 : NJM271D
 - IC9 : NJM2711D
 - IC10 : NJM580L-D
- Q1-3, Q4,5 : UN4219 or 2SC2458Y (GR) or 2SC2311A (DR)

Q6-9 : DTC1132S

Q10,11,13,14 : UN4119 or DTA1132S

Q12 : 2SC2003L(K)

D1-46,67-69,101-106,151 : 1SS133 or HSS104

D51-59 : B-30-2479-05

D60,63,66 : B30-2453-05

D61,62 : B30-1291-05

D64,65 : B30-0425-05

D71-83 : RDS-1E1(B) or HZ55-1N(B)2

DESTINATION		SEB	LnT No.	F4.5	F6	F7	F8	F9,10
U.S.A.	K	0-10	250V 2A	125V 4A	250V 1.25A	125V 4A	4V 20V	
GENERAL MARKET	M	0-21	250V T1AL	250V T1.5AL	250V T1AL	250V T1.5AL	1.25V T1.5AL	

DESTINATION		SEB	LnT No.	F1
U.S.A.	K	0-10	4A 250V	
GENERAL MARKET	M	0-21	T1.25A 1.250V	

(X05-4570-10)		Q1	2SC3547A
IC1	LMK1511TRX	IC2	MRF2C501R2
IC3	TK11250AU	D1	5VC1212(3)
IC4	NJM2058M	D2	15V239
IC5	74HC17046AD	D3	DA204K
IC6	NJM224M		
IC7	UPC2708T-E3		
IC8	UPC2748T-E3		



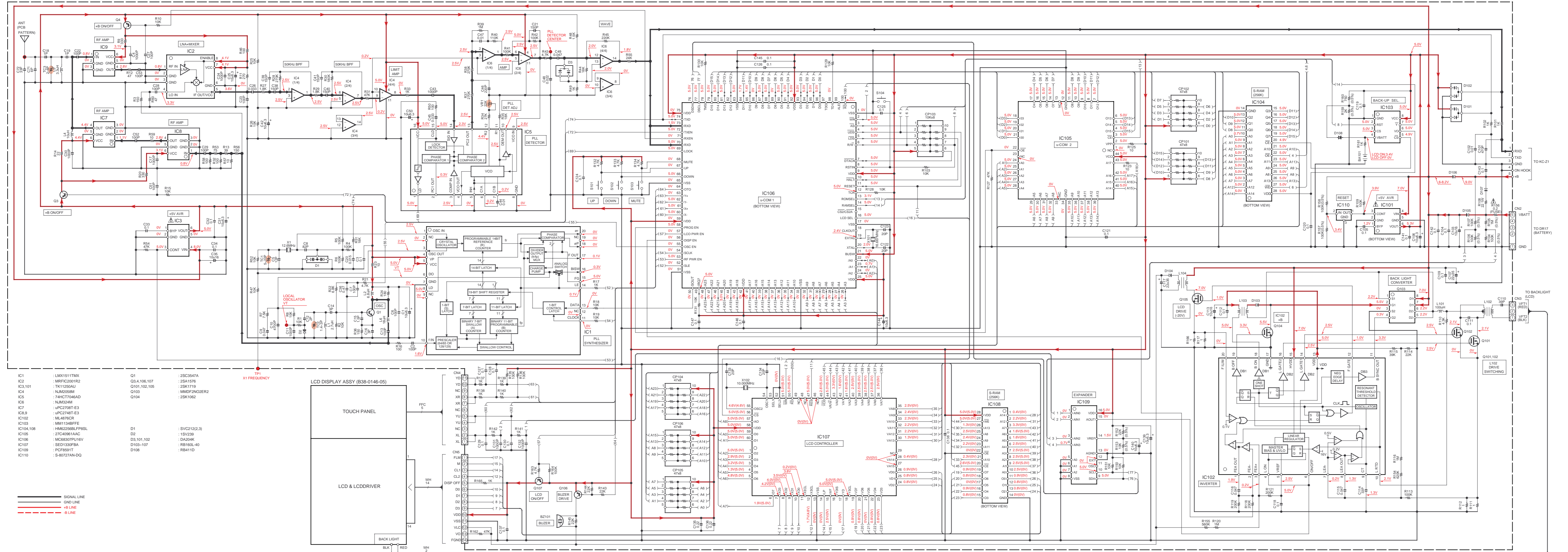

IC1	:LMX1511TMX	Q1	:2SC3547A
IC2	:MRFC200IR2	Q3,4,106,107	:2SA1576
IC3,101	:TK11250AU	Q101,102,105	:2SK1719
IC4	:NMJ2058M	Q103	:MMDF2N02ER2
IC5	:74HC7046AD	Q104	:2SK1062
IC6	:NMS324M		
IC7	:uPC2708T-E3		
IC8,9	:uPC2748T-E3		
IC102	:ML4876C		
IC103	:MM11348FFE		
IC104,108	:HM622568LFPBSL	D1	:SVC212(2,3)
IC105	:27C40961AAC	D2	:1SV239
IC106	:MC88307PU16V	D3,101,102	:DA204K
IC107	:SED1339FBA	D103-107	:RB166L-40
IC109	:PCF8591T	D108	:RB411D
IC110	:S-80727AN-DQ		

— SIGNAL LINE
 — GND LINE
 — +B LINE
 - - - - - -B LINE

CAUTION: For continued safety, replace safety critical components only with manufacturer's recommended parts (refer to parts list). ⚠ indicates safety critical components. For continued protection against risk of fire, replace only with same type and rating fuse(s). To reduce the risk of electric shock, leakage-current or resistance measurements shall be carried out (exposed parts are acceptably insulated from the supply circuit) before the appliance is returned to the customer.

The DC voltage is an actual reading measured with a high impedance type voltmeter with no signal input. The measurement value may vary depending on the measuring instruments used or on the product.

DOLBY and the double-D symbol are trademarks of Dolby Laboratories Licensing Corporation. Noise reduction circuit made under license from Dolby Laboratories Licensing Corporation.

EXPLODED VIEW

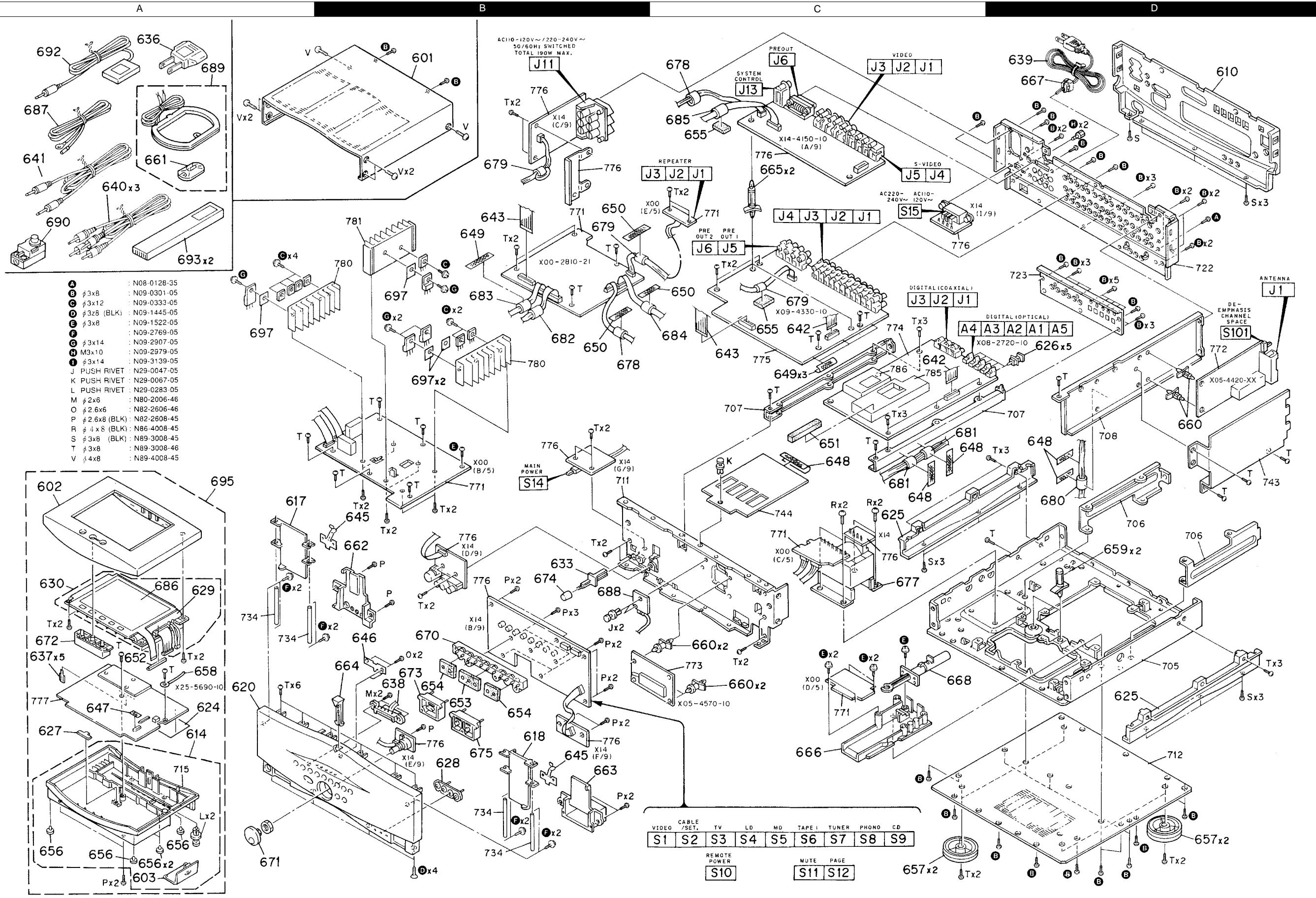

- A N08-0128-35
- B φ3x8 : N09-0301-05
- C φ3x12 : N09-0333-05
- D φ3x8 (BLK) : N09-1445-05
- E φ3x8 : N09-1522-05
- F φ3x8 : N09-2769-05
- G φ3x14 : N09-2907-05
- H M3x10 : N09-2979-05
- I φ3x14 : N09-3139-05
- J PUSH RIVET : N29-0047-05
- K PUSH RIVET : N29-0067-05
- L PUSH RIVET : N29-0283-05
- M φ2x6 : N80-2006-46
- O φ2.6x6 : N82-2606-46
- P φ2.6x8 (BLK) : N82-2608-45
- R φ4x8 (BLK) : N86-4008-45
- S φ3x8 (BLK) : N89-3008-45
- T φ3x8 : N89-3008-46
- V φ4x8 : N89-4008-45

2

3

PARTS LIST

Ñ New Parts

Parts without **Parts No.** are not supplied.

Les articles non mentionnés dans le **Parts No.** ne sont pas fournis.

Teile ohne **Parts No.** werden nicht geliefert.

1

Ref. No	Add-ress	New Parts	Parts No.	Description	Desti-nation	Re-marks
KC-Z1 / RC-Z1						
601	1B	Ñ	A01-3290-31	METALLIC CABINET		
602	2A	Ñ	A02-1280-11	PLASTIC CABINET (RC-Z1)		
603	3A	Ñ	A09-0334-13	BATTERY COVER (RC-Z1)		
610	1D	Ñ	A21-1897-11	DRESSING PANEL(REAR)	K	
610	1D	Ñ	A21-1898-01	DRESSING PANEL(REAR)	M	
614	3A	Ñ	A46-0294-23	REAR COVER ASSY (RC-Z1)		
617	2A	Ñ	A53-1926-14	FRONT BOARD		
618	3B	Ñ	A53-1927-04	FRONT BOARD		
620	3A	Ñ	A60-0847-21	PANEL		
624	2D	Ñ	B03-2967-04	DRESSING PLATE(BATTERY:RC-Z1)		
625	2C,3D	Ñ	B07-2297-02	ESCUTCHEON		
626	2D	Ñ	B09-0097-05	OPTICAL CAP		
627	3A	Ñ	B12-0219-04	INDICATOR (RC-Z1)		
628	3B	Ñ	B12-0266-04	INDICATOR		
629	2A	Ñ	B30-2491-08	FLUORESCENT TUBE (RC-Z1)		
630	2A	Ñ	B38-0146-05	LCD DISPLAY ASSY (RC-Z1)		
-			B46-0092-43	WARRANTY CARD K		
-			B46-0121-33	WARRANTY CARD K		
-			B46-0197-00	QUESTIONNAIRE CARD	K	
-			B58-0966-13	CAUTION CARD (ELM/PL)	M	
-			B58-0967-03	CAUTION CARD (P/PL)	K	
-		Ñ	B60-2476-00	INSTRUCTION MANUAL(ENGLISH)		
-		Ñ	B60-2477-00	INSTRUCTION MANUAL(FRENCH)	K	
-		Ñ	B60-2478-00	INSTRUCTION MANUAL(CHINESE)	M	
-		Ñ	B60-2479-00	INSTRUCTION MANUAL(TAIWANESE)	M	
-		Ñ	B60-2724-00	INSTRUCTION MANUAL(SPANISH)	M	
-		Ñ	B60-2758-00	INSTRUCTION MANUAL(ENGLISH)		
-		Ñ	B60-2759-00	INSTRUCTION MANUAL(FRENCH)	K	
-		Ñ	B60-2760-00	INSTRUCTION MANUAL(CHINESE)	M	
-		Ñ	B60-2761-00	INSTRUCTION MANUAL(TAIWANESE)	M	
-		Ñ	B60-2762-00	INSTRUCTION MANUAL(SPANISH)	M	
633	2B	Ñ	D21-1821-14	EXTENSION SHAFT		
Δ 636	1A		E03-0115-05	AC PLUG ADAPTOR	M	
637	3A	Ñ	E23-1709-04	TERMINAL (RC-Z1)		
638	3B	Ñ	E23-1713-05	TERMINAL		
Δ 639	1D		E30-2592-15	AC POWER CORD	M	
Δ 639	1D		E30-2650-05	AC POWER CORD	K	
640	1A		E30-2600-05	CORD WITH PLUG(AUDIO CORD)		
641	1A		E30-2733-05	CORD WITH PLUG(MINI PLUG)		
642	2C	Ñ	E35-0444-05	WIRING HARNESS(FFC)		
643	1B,2C	Ñ	E35-1308-05	FLAT CABLE(FFC)		
645	2B,3B	Ñ	G02-1083-04	FLAT SPRING		
646	3B	Ñ	G02-1084-04	FLAT SPRING		
647	3A		G10-0170-04	NON-WOVEN FABRIC (RC-Z1)		
648	2C,2D	Ñ	G10-0179-04	NON-WOVEN FABRIC		
649	1B,2C	Ñ	G10-0427-04	NON-WOVEN FABRIC		
650	1C,2B	Ñ	G10-0428-04	NON-WOVEN FABRIC		
651	2C	Ñ	G11-2254-04	CUSHION		
652	3A	Ñ	G11-2261-04	CUSHION (RC-Z1)		
653	3B	Ñ	G11-2263-04	CUSHION		
654	3B	Ñ	G11-2264-04	CUSHION		

L : Scandinavia

K : USA

P : Canada

R : Mexico

Y : PX(Far East, Hawaii)

T : Europe

E : Europe

G : Germany

Y : AAFES(Europe)

X : Australia

M : Other Areas

Δ indicates safety critical components.

Ñ New Parts

Parts without **Parts No.** are not supplied.

Les articles non mentionnés dans le **Parts No.** ne sont pas fournis.

Teile ohne **Parts No.** werden nicht geliefert.

2

Ref. No	Add-ress	New Parts	Parts No.	Description	Desti-nation	Re-marks
655	1C,2C	Ñ	G11-2277-04	CUSHION		
656	3A	Ñ	G13-0182-04	CUSHION (RC-Z1)		
-		Ñ	H10-7124-12	POLYSTYRENE FOAMED FIXTURE		
-		Ñ	H10-7125-12	POLYSTYRENE FOAMED FIXTURE		
-		Ñ	H10-7177-02	POLYSTYRENE FOAMED FIXTURE		
-		Ñ	H10-7178-02	POLYSTYRENE FOAMED FIXTURE		
-		Ñ	H12-2275-04	PACKING FIXTURE (RC-Z1)		
-		Ñ	H13-0229-04	CARTON BOARD (KC-Z1)		
-		Ñ	H13-0230-04	CARTON BOARD (RC-Z1)		
-		Ñ	H25-0232-04	PROTECTION BAG (235X350X0.03)		
-		Ñ	H25-0336-04	PROTECTION BAG (RC-Z1)		
-		Ñ	H25-0383-04	PROTECTION BAG		
-		Ñ	H25-1565-04	PROTECTION BAG (RC-Z1)		
-		Ñ	H25-1566-04	PROTECTION BAG (RC-Z1)		
-		Ñ	H25-1577-04	PROTECTION BAG		
-		Ñ	H50-1733-04	ITEM CARTON CASE (KC-Z1)		
-		Ñ	H50-1874-04	ITEM CARTON CASE (RC-Z1)		
657	3C,3D	Ñ	J02-1142-05	FOOT		
658	3A	Ñ	J19-0306-05	LEAD HOLDER (RC-Z1)		
659	2D	Ñ	J19-3176-05	UNIT HOLDER		
660	3C,3D	Ñ	J19-3324-15	UNIT HOLDER		
661	1A	Ñ	J19-3645-05	LOOP ANTENNA STAND		
662	2B	Ñ	J19-5630-03	HOLDER		
663	3B	Ñ	J19-5631-03	HOLDER		
664	3B	Ñ	J19-5633-14	HOLDER		
665	1C	Ñ	J19-5667-05	UNIT HOLDER		
666	3C	Ñ	J19-5682-23	HOLDER ASSY		
Δ 667	1D		J42-0083-05	POWER CORD BUSHING		
668	3C	Ñ	J52-0038-05	PUSH LATCH		
670	3B	Ñ	K29-6292-03	KNOB (INPUT SELECTOR)		
671	3A	Ñ	K29-6293-04	KNOB (VOLUME)		
672	3A	Ñ	K29-6296-13	KNOB (MUTE,VOLUME) (RC-Z1)		
673	3B	Ñ	K29-6306-03	KNOB (REMOTE POWER)		
674	2B	Ñ	K29-6307-04	KNOB (MAIN POWER)		
675	3B	Ñ	K29-6308-03	KNOB (MUTE,PAGE)		
Δ 677	2C	Ñ	L07-2090-15	POWER TRANSFORMER	K	
Δ 677	2C	Ñ	L07-2105-15	POWER TRANSFORMER	M	
678	2B	Ñ	L92-0058-05	FERRITE CORE		
679	1B,1C	Ñ	L92-0059-05	FERRITE CORE		
680	2D	Ñ	L92-0060-05	FERRITE CORE		
681	2C	Ñ	L92-0061-05	FERRITE CORE		
682	1B	Ñ	L92-0062-05	FERRITE CORE		
683	2B	Ñ	L92-0063-05	FERRITE CORE		
684	2C	Ñ	L92-0064-05	FERRITE CORE		
685	1C	Ñ	L92-0065-05	FERRITE CORE		
686	2A	Ñ	S79-0024-05	TOUCH SENSOR (RC-Z1)		
687	1A		T90-0176-05	T TYPE ANTENNA		
688	3B	Ñ	T90-0814-05	ANTENNA ELEMENT		
689	1A	Ñ	T90-0826-05	LOOP ANTENNA		
690	1A	Ñ	T90-0827-05	ANTENNA ADAPTOR		
692	1A		W02-2542-05	TRANSMITTING ASSY		
693	1A	Ñ	W03-4898-05	BATTERY		

L : Scandinavia

K : USA

P : Canada

R : Mexico

Y : PX(Far East, Hawaii)

T : Europe

E : Europe

G : Germany

Y : AAFES(Europe)

X : Australia

M : Other Areas

Δ indicates safety critical components.

PARTS LIST

Äñ New Parts

Parts without **Parts No.** are not supplied.

Les articles non mentionnés dans le **Parts No.** ne sont pas fournis.

Teile ohne **Parts No.** werden nicht geliefert.

③

Ref. No	Add-ress	New Parts	Parts No.	Description	Desti-nation	Re-marks
695	2A	Äñ	X94-1080-10	REMOTE CONTROL ASSY UNIT		
POWER SUPPLY UNIT (X00-2810-XX)						
C1 -3			CK45FF1H223Z	CERAMIC	0.022UF	Z
C4			CE04KW1C332M	ELECTRO	3300UF	16WV
C5			CE04KW1C102M	ELECTRO	1000UF	16WV
C6			CE04KW1A101M	ELECTRO	100UF	10WV
C7			CQ93FMG1H103J	MYLAR	0.010UF	J
C8			CE04KW1A101M	ELECTRO	100UF	10WV
C9			CQ93FMG1H103J	MYLAR	0.010UF	J
C10			CE04KW0J331M	ELECTRO	330UF	6.3WV
C11			CE04KW1C222M	ELECTRO	2200UF	16WV
C12 ,13			CQ93FMG1H104J	MYLAR	0.10UF	J
C14 ,15			CE04KW1A101M	ELECTRO	100UF	10WV
C16 -19			CQ93FMG1H104J	MYLAR	0.10UF	J
C20			CE04KW1E470M	ELECTRO	47UF	25WV
C21 -26			CK45FF1H223Z	CERAMIC	0.022UF	Z
C27 ,28			CE04KW1E472M	ELECTRO	4700UF	25WV
C29 ,30			CQ93FMG1H104J	MYLAR	0.10UF	J
C31 ,32			CQ93FMG1H103J	MYLAR	0.010UF	J
C33			CE04KW1A102M	ELECTRO	1000UF	10WV
C34			CE04KW1A221M	ELECTRO	220UF	10WV
C35 -38			CQ93FMG1H104J	MYLAR	0.10UF	J
C39 -45			CK45FF1H223Z	CERAMIC	0.022UF	Z
C46 ,47			CE04KW1V222M	ELECTRO	2200UF	35WV
C48 ,49			CE04KW1E101M	ELECTRO	100UF	25WV
C50 -53			CE04KW1E470M	ELECTRO	47UF	25WV
C54 ,55			CQ93FMG1H104J	MYLAR	0.10UF	J
C56			CE04KW1A101M	ELECTRO	100UF	10WV
C61			CE04KW1H100M	ELECTRO	10UF	50WV
C62			CE04KW1E470M	ELECTRO	47UF	25WV
C63			CE04KW1H100M	ELECTRO	10UF	50WV
C71 -73			CK45FF1H223Z	CERAMIC	0.022UF	Z
C74 ,75			CE04KW1E472M	ELECTRO	4700UF	25WV
C76			CF92FV1H105J	MF-C	1.0UF	J
C77			CE04KW1E101M	ELECTRO	100UF	25WV
C78			CE04KW1E470M	ELECTRO	47UF	25WV
C81			CE04KW1A101M	ELECTRO	100UF	10WV
C82 ,83			CC45FSL1H221J	CERAMIC	220PF	J
C85 ,86			CE04KW1E101M	ELECTRO	100UF	25WV
C87 ,88			CQ93FMG1H104J	MYLAR	0.10UF	J
C91 ,92			CQ93FMG1H103J	MYLAR	0.010UF	J
C93			CE04KW1A101M	ELECTRO	100UF	10WV
C94			CK45FF1H223Z	CERAMIC	0.022UF	Z
C95			CK45FF1H103Z	CERAMIC	0.010UF	Z
C96			CQ93FMG1H104J	MYLAR	0.10UF	J
C101			CE04KW1A101M	ELECTRO	100UF	10WV
C102,103			CQ93FMG1H104J	MYLAR	0.10UF	J
C104,105			CE04KW1A101M	ELECTRO	100UF	10WV
C106-109			CQ93FMG1H104J	MYLAR	0.10UF	J
C110			CE04KW1H010M	ELECTRO	1.0UF	50WV
C111,112			CE04KW1E470M	ELECTRO	47UF	25WV
C121,122			CE04KW1A221M	ELECTRO	220UF	10WV
C123			CE04KW1A101M	ELECTRO	100UF	10WV
C124,125			CQ93FMG1H104J	MYLAR	0.10UF	J

L : Scandinavia

K : USA

P : Canada

R : Mexico

Y : PX(Far East, Hawaii)

T : Europe

E : Europe

G : Germany

Y : AAFES(Europe)

X : Australia

M : Other Areas

⚠ indicates safety critical components.

Äñ New Parts

Parts without **Parts No.** are not supplied.

Les articles non mentionnés dans le **Parts No.** ne sont pas fournis.

Teile ohne **Parts No.** werden nicht geliefert.

④

Ref. No	Add-ress	New Parts	Parts No.	Description	Desti-nation	Re-marks
C126			CE04KW1A221M	ELECTRO	220UF	10WV
C127			CK45FF1H223Z	CERAMIC	0.022UF	Z
C128,129			CE04KW1H010M	ELECTRO	1.0UF	50WV
C130			CC45FCH1H180J	CERAMIC	18PF	J
C131			CC45FCH1H220J	CERAMIC	22PF	J
C132			C90-1827-05	ELECTRO	0.047F	5.5WV
C141			CE04KW1H010M	ELECTRO	1.0UF	50WV
C142			CE04KW1H0R1M	ELECTRO	0.1UF	50WV
C143			CE04KW1A101M	ELECTRO	100UF	10WV
C144			CK45FF1H223Z	CERAMIC	0.022UF	Z
C145,146			CC45FCH1H101J	CERAMIC	100PF	J
C147,148			CE04KW1E470M	ELECTRO	47UF	25WV
C149			CQ93FMG1H104J	MYLAR	0.10UF	J
C151,152			CE04KW0J331M	ELECTRO	330UF	6.3WV
C153			CE04KW1A101M	ELECTRO	100UF	10WV
C154			CQ93FMG1H104J	MYLAR	0.10UF	J
C155			CQ93FMG1H103J	MYLAR	0.010UF	J
C156			CE04KW1A101M	ELECTRO	100UF	10WV
C157			CQ93FMG1H104J	MYLAR	0.10UF	J
C158			CK45FF1H223Z	CERAMIC	0.022UF	Z
C159			CQ93FMG1H104J	MYLAR	0.10UF	J
C160			CE04KW0J331M	ELECTRO	330UF	6.3WV
C161			CE04KW1A471M	ELECTRO	470UF	10WV
C162-167			CK45FF1H103Z	CERAMIC	0.010UF	Z
C168,169			CQ93FMG1H103J	MYLAR	0.010UF	J
C171-178			CQ93FMG1H104J	MYLAR	0.10UF	J
CN1			E40-3263-05	PIN ASSY		
CN2			E40-4293-05	FLAT CABLE CONNECTOR		
CN3			E40-4284-05	FLAT CABLE CONNECTOR		
CN4			E40-4608-05	PIN ASSY		
CN5			E40-4295-05	FLAT CABLE CONNECTOR		
CN6	2B		E40-4914-05	FLAT CABLE CONNECTOR		
CN7			E40-4368-05	PIN ASSY		
CN8			E40-3254-05	PIN ASSY		
CN9			E40-9814-05	PIN ASSY		
J1 -3			E11-0220-05	MINIATURE PHONE JACK		
△ 697	1A,1B		F20-1405-15	INSULATING SHEET		
△ F4 ,5			F04-2025-05	FUSE (UL)	(250V 2A)	K
△ F4 ,5			F06-1022-05	FUSE (SEMKO)	(250V T1AL)	M
△ F6			F05-1623-05	FUSE (SEMKO)	(250V T1.6AL)	M
△ F6			F05-4028-05	FUSE (UL)	(125V 4A)	K
△ F7		Äñ	F06-1022-05	FUSE (SEMKO)	(250V T1AL)	M
△ F7			F06-1222-05	FUSE (UL)	(250V 1.25A)	K
△ F8			F05-4028-05	FUSE (UL)	(125V 4A)	K
△ F8			F06-2021-05	FUSE (SEMKO)	(250V T2AL)	M
△ F9 ,10			F04-2025-05	FUSE (UL)	(250V 2A)	K
△ F9 ,10			F05-1623-05	FUSE (SEMKO)	(250V T1.6AL)	M
CN11-24			J13-0075-05	FUSE CLIP		
L1 -7			L92-0044-05	FERRITE CORE		
L8 -11			L92-0017-05	FERRITE CORE		
L21 -24			L92-0044-05	FERRITE CORE		
L25 ,26			L92-0017-05	FERRITE CORE		
L27 -30			L92-0044-05	FERRITE CORE		

L : Scandinavia

K : USA

P : Canada

R : Mexico

Y : PX(Far East, Hawaii)

T : Europe

E : Europe

G : Germany

Y : AAFES(Europe)

X : Australia

M : Other Areas

⚠ indicates safety critical components.

PARTS LIST

Ñ New Parts

Parts without **Parts No.** are not supplied.

Les articles non mentionnés dans le **Parts No.** ne sont pas fournis.

Teile ohne **Parts No.** werden nicht geliefert.

5

Ref. No	Add-ress	New Parts	Parts No.	Description	Desti-nation	Re-marks
L31 -33			L92-0017-05	FERRITE CORE		
L34 -37			L92-0044-05	FERRITE CORE		
L40		Ñ	L92-0059-05	FERRITE CORE		
L41			L92-0044-05	FERRITE CORE		
X1		Ñ	L78-0663-05	RESONATOR (4.150MHZ)		
X2			L77-2140-05	CRYSTAL RESONATOR(32.768KHZ)		
X3		Ñ	L78-0639-05	RESONATOR (780KHZ)		
X4			L78-0244-05	RESONATOR (4.000M)		
CP1			R90-0493-05	MULTI-COMP 100KX9 J 1/6W		
CP2			R90-0483-05	MULTI-COMP 100KX13 J 1/6W		
CP3			R90-0802-05	MULTI-COMP 100KX10 J 1/4W		
CP4			R90-0851-05	MULTI-COMP 100KX11		
CP5			R90-0802-05	MULTI-COMP 100KX10 J 1/4W		
CP6			R90-0855-05	MULTI-COMP 100KX5 J		
CP7			R90-0805-05	MULTI-COMP 10KX8 J 1/4W		
CP8 -12			R90-0810-05	MULTI-COMP 10K X6		
CP13			R90-0805-05	MULTI-COMP 10KX8 J 1/4W		
CP14,15			R90-0809-05	MULTI-COMP 10KX4 J 1/6W		
CP16			R90-0805-05	MULTI-COMP 10KX8 J 1/4W		
R21 ,22			R92-0341-05	FUSE RESIST 4.7 J 1/4W		
R31			RS14DB3D102J	FL-PROOF RS 1.0K J 2W		
R41			RS14DB3D1R0J	FL-PROOF RS 1.0 J 2W		
R51			RS14DB3D1R0J	FL-PROOF RS 1.0 J 2W		
R57			RS14DB3D181J	FL-PROOF RS 180 J 2W		
R74		Ñ	RS14DB3D1R2J	FL-PROOF RS 1.2 J 2W		
R273			RS14DB3A100J	FL-PROOF RS 10 J 1W		
R287			RS14DB3A1R0J	FL-PROOF RS 1.0 J 1W		
R288-290			RS14DB3A6R8J	FL-PROOF RS 6.8 J 1W		
K1 ,2			S51-2094-05	MAGNETIC RELAY		
D1 ,2			KBP02ML-6127	DIODE		
D3			S5688B	DIODE		
D3			1SR139-100	DIODE		
D4			HZS2.7N(B2)	ZENER DIODE		
D4			RD2.7ES(B2)	ZENER DIODE		
D5			HSS104	DIODE		
D5			1SS133	DIODE		
D7 ,8			HSS104	DIODE		
D7 ,8			1SS133	DIODE		
D9 ,10			HZS10N(B)	ZENER DIODE		
D9 ,10			RD10ES(B)	ZENER DIODE		
D11			HZS5.1N(B2)	ZENER DIODE		
D11			RD5.1ES(B2)	ZENER DIODE		
D12			D5SBA20F03	DIODE		
D12			RBV-602LFA	DIODE		
D13			KBP02ML-6127	DIODE		
D14			D3SBA20F03	DIODE		
D14			RBV-402LFA	DIODE		
D15			S5688B	DIODE		
D15			1SR139-100	DIODE		
D16 -21			HSS104	DIODE		
D16 -21			1SS133	DIODE		
D22			HZS5.1N(B2)	ZENER DIODE		
D22			RD5.1ES(B2)	ZENER DIODE		
D23 -25			HSS104	DIODE		

L : Scandinavia

K : USA

P : Canada

R : Mexico

Y : PX(Far East, Hawaii)

T : Europe

E : Europe

G : Germany

Y : AAFES(Europe)

X : Australia

M : Other Areas

Δ indicates safety critical components.

Ñ New Parts

Parts without **Parts No.** are not supplied.

Les articles non mentionnés dans le **Parts No.** ne sont pas fournis.

Teile ohne **Parts No.** werden nicht geliefert.

5

Ref. No	Add-ress	New Parts	Parts No.	Description	Desti-nation	Re-marks
D23 -25			1SS133	DIODE		
D26 ,27			HZS5.1N(B2)	ZENER DIODE		
D26 ,27			RD5.1ES(B2)	ZENER DIODE		
D28 ,29			HSS104	DIODE		
D28 ,29			1SS133	DIODE		
D41			S5688B	DIODE		
D41			1SR139-100	DIODE		
D42 -44			HSS104	DIODE		
D42 -44			1SS133	DIODE		
D47 ,48			HSS104	DIODE		M
D47 ,48			1SS133	DIODE		M
D49			S5688B	DIODE		
D49			1SR139-100	DIODE		
D50 -63			HSS104	DIODE		
D50 -63			1SS133	DIODE		
D64			HZS7.5S(B)	ZENER DIODE		
D64			RD7.5JS(B)	ZENER DIODE		
D65 -68			HSS104	DIODE		
D65 -68			1SS133	DIODE		
D69			S5688B	DIODE		
D69			1SR139-100	DIODE		
D70 -73			HSS104	DIODE		
D70 -73			1SS133	DIODE		
D74			HZS5.1N(B2)	ZENER DIODE		
D74			RD5.1ES(B2)	ZENER DIODE		
Δ IC1			TA7805S	IC(VOLTAGE REGULATOR/ +5V)		
Δ IC1			UPC7805AHF	IC(VOLTAGE REGULATOR/ +5V)		
Δ IC2			TA79005S	IC(VOLTAGE REGULATOR/ -5V)		
Δ IC2			UPC7905HF	IC(VOLTAGE REGULATOR/ -5V)		
Δ IC3			SI-3052V	ANALOGUE IC		
IC4			NJM4580D-D	IC(OP AMP X2)		
IC5 -7			TL431CLP	MOS-IC		
Δ IC8			SI-3082V	ANALOGUE IC		
Δ IC9			TA79008S	IC(VOLTAGE REGULATOR/ -8V)		
Δ IC9			UPC7908HF	IC(VOLTAGE REGULATOR/ -8V)		
Δ IC10			TA7805S	IC(VOLTAGE REGULATOR/ +5V)		
Δ IC10			UPC7805AHF	IC(VOLTAGE REGULATOR/ +5V)		
Δ IC11			TA7808S	IC(VOLTAGE REGULATOR/ +8V)		
Δ IC11			UPC7808AHF	IC(VOLTAGE REGULATOR/ +8V)		
Δ IC12			TA7812S	IC(VOLTAGE REGULATOR/ +12V)		
Δ IC12			UPC7812AHF	IC(VOLTAGE REGULATOR/ +12V)		
Δ IC13			TA79012S	IC(VOLTAGE REGULATOR/ -12V)		
Δ IC13			UPC7912HF	IC(VOLTAGE REGULATOR/ -12V)		
IC31			78P078GF1ABA	MI-COM IC		
IC32			S-806D-Z	ANALOGUE IC		
IC33			DCC5555A/22	MI-COM IC		
IC34		Ñ	SC401737FU	MI-COM IC		
IC35			XL24C01AP	MEMORY IC		
Q1			2SC2003(L,K)	TRANSISTOR		
Q3			2SB1370	TRANSISTOR		
Δ Q3			2SB1375	TRANSISTOR		
Δ Q4			2SD2012	TRANSISTOR		
Δ Q4			2SD2061	TRANSISTOR		
Q5			2SA992(F,E)	TRANSISTOR		
Q6			2SC1845(F,E)	TRANSISTOR		

L : Scandinavia

K : USA

P : Canada

R : Mexico

Y : PX(Far East, Hawaii)

T : Europe

E : Europe

G : Germany

Y : AAFES(Europe)

X : Australia

M : Other Areas

Δ indicates safety critical components.

PARTS LIST

Ñ New Parts

Parts without **Parts No.** are not supplied.

Les articles non mentionnés dans le **Parts No.** ne sont pas fournis.

Teile ohne **Parts No.** werden nicht geliefert.



Ref. No	Add-ress	New Parts	Parts No.	Description	Desti-nation	Re-marks
Q7			2SA992(F,E)	TRANSISTOR		
Q8 ,9			2SC1845(F,E)	TRANSISTOR		
Q10			DTC124ES	DIGITAL TRANSISTOR		
Q10			UN4212	DIGITAL TRANSISTOR		
Q11			DTA113ZS	DIGITAL TRANSISTOR		
Q11			UN4119	DIGITAL TRANSISTOR		
Q12			2SA992(F,E)	TRANSISTOR		
Q13			2SC1845(F,E)	TRANSISTOR		
Q14			DTC124ES	DIGITAL TRANSISTOR		
Q14			UN4212	DIGITAL TRANSISTOR		
Δ Q15 ,16			2SB1587	TRANSISTOR		
Δ Q17			2SD2012	TRANSISTOR		
Δ Q17			2SD2061	TRANSISTOR		
Δ Q18			2SB1370	TRANSISTOR		
Δ Q18			2SB1375	TRANSISTOR		
Q31			DTC124ES	DIGITAL TRANSISTOR		
Q31			UN4212	DIGITAL TRANSISTOR		
Q32			2SC2003(L,K)	TRANSISTOR		
Q33			2SC1845(F,E)	TRANSISTOR		
Q34			2SA992(F,E)	TRANSISTOR	M	
Q35			2SC1845(F,E)	TRANSISTOR		
Q36			2SC2003(L,K)	TRANSISTOR		
Q39 -41			2SB772	TRANSISTOR		
Q42			DTC124ES	DIGITAL TRANSISTOR		
Q42			UN4212	DIGITAL TRANSISTOR		
Q43			2SC1845(F,E)	TRANSISTOR		
Q44			DTA124ES	DIGITAL TRANSISTOR		
Q44			UN4112	DIGITAL TRANSISTOR		
Q45			2SC2003(L,K)	TRANSISTOR		
TUNER UNIT (X05-4420-XX)						
C1 ,2			CK73FB1H103K	CHIP C	0.010UF	K
C4			CE04KW1A470M	ELECTRO	47UF	10WV
C5			CK73FB1H103K	CHIP C	0.010UF	K
C8			CK73FB1H103K	CHIP C	0.010UF	K
C10			CK73FB1H102K	CHIP C	1000PF	K
C11			CE04KW1H4R7M	ELECTRO	4.7UF	50WV
C13			CE04KW1H010M	ELECTRO	1.0UF	50WV
C14			CE04KW1H2R2M	ELECTRO	2.2UF	50WV
C21 ,22			CQ92FM1H163J	MYLAR	0.016UF	J
C21 ,22	Ñ		CQ92FM1H243J	MYLAR	0.024UF	J
C23			CE04KW1H010M	ELECTRO	1.0UF	50WV
C24			CE04KW1H3R3M	ELECTRO	3.3UF	50WV
C25			CE04KW1V100M	ELECTRO	10UF	35WV
C27			CK73FB1E473K	CHIP C	0.047UF	K
C28			CE04KW1V100M	ELECTRO	10UF	35WV
C31			CE04KW1A470M	ELECTRO	47UF	10WV
C32			CK73FB1H103K	CHIP C	0.010UF	K
C33			CC73FCH1H270J	CHIP C	27PF	J
C34			CC73FCH1H220J	CHIP C	22PF	J
C35 -38			CK73FB1H471K	CHIP C	470PF	K
C39			CE04KW1C470M	ELECTRO	47UF	16WV
C40			CK73FB1H223K	CHIP C	0.022UF	K
C41			CE04KW1H010M	ELECTRO	1.0UF	50WV
C42 ,43			CK73FB1H103K	CHIP C	0.010UF	K
C50			C91-0769-05	CERAMIC	0.010UF	K

L : Scandinavia

K : USA

P : Canada

R : Mexico

Y : PX(Far East, Hawaii)

T : Europe

E : Europe

G : Germany

Y : AAFES(Europe)

X : Australia

M : Other Areas

Δ indicates safety critical components.

Ñ New Parts

Parts without **Parts No.** are not supplied.

Les articles non mentionnés dans le **Parts No.** ne sont pas fournis.

Teile ohne **Parts No.** werden nicht geliefert.



Ref. No	Add-ress	New Parts	Parts No.	Description	Desti-nation	Re-marks
C51			CE04KW1H010M	ELECTRO	1.0UF	50WV
C52			CE04KW1C470M	ELECTRO	47UF	16WV
C57			CC73FSL1H220J	CHIP C	22PF	J
C65			CE04KW1H010M	ELECTRO	1.0UF	50WV
C66			CK73FB1H102K	CHIP C	1000PF	K
C71			CE04KW1V100M	ELECTRO	10UF	35WV
C72			CE04KW1C470M	ELECTRO	47UF	16WV
C103-106			CE04KW1HR47M	ELECTRO	0.47UF	50WV
C107			CK73FB1E473K	CHIP C	0.047UF	K
C112			CC73FSL1H101J	CHIP C	100PF	J
C114			CK73FB1H681K	CHIP C	680PF	K
C115,116			CC73FSL1H101J	CHIP C	100PF	J
C121,122			CE04KW1C470M	ELECTRO	47UF	16WV
C135,136			CQ92FM1H682J	MYLAR	6800PF	J
C182			CC73FSL1H150J	CHIP C	15PF	J
CN1			E40-4234-05	FLAT CABLE CONNECTOR		
J1			E20-0321-05	LOCK TERMINAL BOARD(2P,F)		
CF1 ,2			L72-0531-05	CERAMIC FILTER		
CF3			L72-0574-05	CERAMIC FILTER		
L7			L30-0467-05	AM IFT		
L10			L40-1091-17	SMALL FIXED INDUCTOR(1UH)		
L11			L40-1021-14	SMALL FIXED INDUCTOR(1.0MH,K)		
L12			L40-1091-17	SMALL FIXED INDUCTOR(1UH)		
L103			L39-1349-05	COMBINATION COIL		
L106		Ñ	L40-1091-17	SMALL FIXED INDUCTOR(1UH)		
X1			L77-2148-05	CRYSTAL RESONATOR(7.2MHZ)		
X2			L78-0295-05	RESONATOR (456KHZ)		
R1			RK73FB2A681J	CHIP R	680	J 1/10W
R2			RK73FB2A332J	CHIP R	3.3K	J 1/10W
R3			RK73FB2A331J	CHIP R	330	J 1/10W
R4			RK73FB2A470J	CHIP R	47	J 1/10W
R6			RK73FB2A331J	CHIP R	330	J 1/10W
Δ R11			RS14KB3A820J	FL-PROOF RS	82	J 1W
R15			RK73FB2A391J	CHIP R	390	J 1/10W
R19			RK73FB2A332J	CHIP R	3.3K	J 1/10W
R21 ,22			RK73FB2A393J	CHIP R	39K	J 1/10W
R24			RK73FB2A102J	CHIP R	1.0K	J 1/10W
R25			RK73FB2A103J	CHIP R	10K	J 1/10W
Δ R31			RS14KB3D221J	FL-PROOF RS	220	J 2W
R32 -37			RK73FB2A102J	CHIP R	1.0K	J 1/10W
R38			RK73FB2A221J	CHIP R	220	J 1/10W
R39			RK73FB2A822J	CHIP R	8.2K	J 1/10W
R40			RK73FB2A102J	CHIP R	1.0K	J 1/10W
Δ R42			RD14NB2E101J	RD	100	J 1/4W
R43			RK73FB2A103J	CHIP R	10K	J 1/10W
R52			RK73FB2A472J	CHIP R	4.7K	J 1/10W
R64			RK73FB2A104J	CHIP R	100K	J 1/10W
R101,102			RK73FB2A333J	CHIP R	33K	J 1/10W
Δ R105,106			RK73FB2A123J	CHIP R	12K	J 1/10W
R111			RD14NB2E470J	RD	47	J 1/4W
R118			RK73FB2A122J	CHIP R	1.2K	J 1/10W
R119			RK73FB2A123J	CHIP R	12K	J 1/10W
R122			RK73FB2A122J	CHIP R	1.2K	J 1/10W
R123			RK73FB2A123J	CHIP R	12K	J 1/10W

L : Scandinavia

K : USA

P : Canada

R : Mexico

Y : PX(Far East, Hawaii)

T : Europe

E : Europe

G : Germany

Y : AAFES(Europe)

X : Australia

M : Other Areas

Δ indicates safety critical components.

PARTS LIST

New Parts

Parts without **Parts No.** are not supplied.
Les articles non mentionnés dans le **Parts No.** ne sont pas fournis.
Teile ohne **Parts No.** werden nicht geliefert.

9

Ref. No	Add-ress	New Parts	Parts No.	Description	Desti-nation	Re-marks
R124			RK73FB2A103J	CHIP R 10K J 1/10W		
R125,126			RK73FB2A332J	CHIP R 3.3K J 1/10W		
R127,128			RD14NB2E101J	RD 100 J 1/4W		
R131,132			RK73FB2A393J	CHIP R 39K J 1/10W		
R138,139			RK73FB2A561J	CHIP R 560 J 1/10W	M	
R140,141			RK73FB2A473J	CHIP R 47K J 1/10W	M	
R151			RK73FB2A821J	CHIP R 820 J 1/10W		
R152			RK73FB2A473J	CHIP R 47K J 1/10W		
R153			RK73FB2A472J	CHIP R 4.7K J 1/10W		
R156,157			RK73FB2A102J	CHIP R 1.0K J 1/10W		
R167			RK73FB2A104J	CHIP R 100K J 1/10W		
W46			R92-0670-05	CHIP R 0 OHM		
W48			R92-0670-05	CHIP R 0 OHM		
S101			S62-0034-05	SLIDE SWITCH	M	
D3			HZS5.1N(B2)	ZENER DIODE		
D3			RD5.1ES(B2)	ZENER DIODE		
D4			HZS3.3N(B2)	ZENER DIODE		
D4			RD3.3ES(B2)	ZENER DIODE		
D7			MA111	DIODE		
D8			HSS104	DIODE		
D8			1SS133	DIODE		
D11			HZS8.2N(B2)	ZENER DIODE		
D11			RD8.2ES(B2)	ZENER DIODE		
D111,112			MA111	DIODE		
IC1			LA1831A-KEN	ANALOGUE IC		
IC2			LC7218	IC(PLL FREQUENCY SYNTHESIZER)		
IC12			NJM4565D	IC(OP AMP X2)		
Q1			2SC2714(R,O)	TRANSISTOR		
Q2			2SC1845(F,E)	TRANSISTOR		
Q3			2SC2458(Y,GR)	TRANSISTOR		
Q3			2SC3311A(Q,R)	TRANSISTOR		
Q7			2SC2412K	TRANSISTOR		
Q11			2SD863(E,F)	TRANSISTOR		
Q102			2SA1037K	TRANSISTOR		
Q104			2SA1037K	TRANSISTOR	M	
Q107-110			2SC2412K	TRANSISTOR	K	
Q109,110			2SC2412K	TRANSISTOR		
Q111			2SA1037K	TRANSISTOR		
			W02-2512-05	FM FRONT-END ASSY		
REMOTE CONTROL RECEIVE/TRANSMIT UNIT (X05-4570-10)						
C1			C92-0509-05	CHIP-TAN 10UF 6.3VWV		
C2			CC73FSL1H101J	CHIP C 100PF J		
C3			CK73EB1H104K	CHIP C 0.10UF K		
C4			CK73FB1H102K	CHIP C 1000PF K		
C5			CC73FCH1H120J	CHIP C 12PF J		
C6,7			CC73FSL1H101J	CHIP C 100PF J		
C8			CC73FCH1H820J	CHIP C 82PF J		
C9			CK73FB1H473K	CHIP C 0,047UF K		
C10			CK73FB1H472K	CHIP C 4700PF K		
C11			CK73FB1H102K	CHIP C 1000PF K		
C12			CC73FUJ1H020C	CHIP C 2.0PF C		
C13			CC73FSL1H101J	CHIP C 100PF J		
C14			CC73FUJ1H030C	CHIP C 3.0PF C		

L : Scandinavia K : USA P : Canada R : Mexico
Y : PX(Far East, Hawaii) T : Europe E : Europe G : Germany
Y : AAFES(Europe) X : Australia M : Other Areas

△ indicates safety critical components.

New Parts

Parts without **Parts No.** are not supplied.
Les articles non mentionnés dans le **Parts No.** ne sont pas fournis.
Teile ohne **Parts No.** werden nicht geliefert.

10

Ref. No	Add-ress	New Parts	Parts No.	Description	Desti-nation	Re-marks
C15			CC73FCH1H1R5C	CHIP C 1.5PF C		
C16			CC73FCH1H030C	CHIP C 3.0PF C		
C17			CK73FB1H102K	CHIP C 1000PF K		
C18,19			CC73FCH1H010C	CHIP C 1.0PF C		
C20			CK73FB1H153K	CHIP C 0.015UF K		
C21			CC73FSL1H151J	CHIP C 150PF J		
C22,23			CC73FSL1H101J	CHIP C 100PF J		
C24			CK73FB1H102K	CHIP C 1000PF K		
C25			C92-0509-05	CHIP-TAN 10UF 6.3VWV		
C26			CK73FB1H333K	CHIP C 0.033UF K		
C27-29			CC73FSL1H101J	CHIP C 100PF J		
C30			CK73FB1H102K	CHIP C 1000PF K		
C31			C92-0509-05	CHIP-TAN 10UF 6.3VWV		
C32-34			CK73EB1H104K	CHIP C 0.10UF K		
C35			C92-0135-05	CHIP(TAN) 47UF 10WV		
C36			CK73EB1C474K	CHIP C 0.47UF K		
C37			CK73FB1H103K	CHIP C 0.010UF K		
C38-41			CC73FSL1H151J	CHIP C 150PF J		
C42			C92-0509-05	CHIP-TAN 10UF 6.3VWV		
C43			CK73FB1H102K	CHIP C 1000PF K		
C44			C93-0030-05	CHIP C 0.01UF J		
C45			CK73FB1H333K	CHIP C 0.033UF K		
C46			CC73FSL1H221J	CHIP C 220PF J		
C47			CK73FB1H103K	CHIP C 0.010UF K		
C48			CK73FB1H223K	CHIP C 0.022UF K		
C49			CK73FB1H473K	CHIP C 0.047UF K		
C50			C92-0509-05	CHIP-TAN 10UF 6.3VWV		
C51-54			CC73FSL1H101J	CHIP C 100PF J		
C55			CC73FCH1H030C	CHIP C 3.0PF C		
C56,57			CC73FSL1H221J	CHIP C 220PF J		
TC1			C05-0233-05	CERAMIC TRIMMER CAPACITOR(5-20 C TRIMMER 1.4-3.0PF		
TC2			C05-0228-05	CERAMIC TRIMMER CAPACITOR(2-6P		
TC3			C05-0229-05	CERAMIC TRIMMER CAPACITOR(2-6P		
CN1			E40-3256-05	PIN ASSY		
J1			E04-0190-05	RF COAXIAL CABLE RECEPTACLE		
L1			L33-1273-05	SMALL FIXED INDUCTOR		
L2			L40-6865-35	SMALL FIXED INDUCTOR(6.8NH)		
L3			L33-1274-05	SMALL FIXED INDUCTOR(3.3NH)		
L4			L40-1075-35	SMALL FIXED INDUCTOR(10NH)		
L5			L33-1272-05	SMALL FIXED INDUCTOR(2.2NH)		
L6			L40-1875-35	SMALL FIXED INDUCTOR(18NH)		
X1			L77-2164-05	CRYSTAL RESONATOR(12.6MHZ)		
R1,2			RK73FB2A103J	CHIP R 10K J 1/10W		
R3			RK73FB2A151J	CHIP R 150 J 1/10W		
R4-6			RK73FB2A104J	CHIP R 100K J 1/10W		
R7			RK73FB2A752J	CHIP R 7.5K J 1/10W		
R8			RK73FB2A103J	CHIP R 10K J 1/10W		
R9			RK73FB2A331J	CHIP R 330 J 1/10W		
R10			RK73FB2A103J	CHIP R 10K J 1/10W		
R11			RK73FB2A271J	CHIP R 270 J 1/10W		
R12			RK73FB2A470J	CHIP R 47 J 1/10W		
R13			RK73FB2A390J	CHIP R 39 J 1/10W		
R14			RK73FB2A220J	CHIP R 22 J 1/10W		
R15			RK73FB2A103J	CHIP R 10K J 1/10W		

L : Scandinavia K : USA P : Canada R : Mexico
Y : PX(Far East, Hawaii) T : Europe E : Europe G : Germany
Y : AAFES(Europe) X : Australia M : Other Areas

△ indicates safety critical components.

PARTS LIST

New Parts
Parts without **Parts No.** are not supplied.
Les articles non mentionnés dans le **Parts No.** ne sont pas fournis.
Teile ohne **Parts No.** werden nicht geliefert.

11

Ref. No	Add-ress	New Parts	Parts No.	Description	Desti-nation	Re-marks
R16			RK73FB2A101J	CHIP R 100 J 1/10W		
R17			RK73FB2A102J	CHIP R 1.0K J 1/10W		
R18 ,19			RK73FB2A103J	CHIP R 10K J 1/10W		
R20			RK73FB2A331J	CHIP R 330 J 1/10W		
R21			RK73FB2A472J	CHIP R 4.7K J 1/10W		
R22			RK73FB2A682J	CHIP R 6.8K J 1/10W		
R23			RK73FB2A100J	CHIP R 10 J 1/10W		
R24			RK73FB2A181J	CHIP R 180 J 1/10W		
R25 ,26			RK73FB2A103J	CHIP R 10K J 1/10W		
R27			RK73FB2A182J	CHIP R 1.8K J 1/10W		
R28			RK73FB2A274J	CHIP R 270K J 1/10W		
R29			RK73FB2A182J	CHIP R 1.8K J 1/10W		
R30			RK73FB2A184J	CHIP R 180K J 1/10W		
R31			RK73FB2A473J	CHIP R 47K J 1/10W		
R32			RK73FB2A750J	CHIP R 75 J 1/10W		
R33			RK73FB2A102J	CHIP R 1.0K J 1/10W		
R34			RK73FB2A273J	CHIP R 27K J 1/10W		
R35			RK73FB2A183J	CHIP R 18K J 1/10W		
R36			RK73FB2A151J	CHIP R 150 J 1/10W		
R37 ,38			RK73FB2A274J	CHIP R 270K J 1/10W		
R39			RK73FB2A105J	CHIP R 1.0M J 1/10W		
R40			RK73FB2A114J	CHIP R 110K J 1/10W		
R41 ,42			RK73FB2A104J	CHIP R 100K J 1/10W		
R43			RK73FB2A472J	CHIP R 4.7K J 1/10W		
R44			RK73FB2A183J	CHIP R 18K J 1/10W		
R45			RK73FB2A224J	CHIP R 220K J 1/10W		
R46			RK73FB2A101J	CHIP R 100 J 1/10W		
R47			RK73FB2A103J	CHIP R 10K J 1/10W		
R48			RK73FB2A152J	CHIP R 1.5K J 1/10W		
R49			RK73FB2A102J	CHIP R 1.0K J 1/10W		
R50			RK73FB2A101J	CHIP R 100 J 1/10W		
R51			RK73FB2A183J	CHIP R 18K J 1/10W		
R52			RK73FB2A103J	CHIP R 10K J 1/10W		
R53			RK73FB2A101J	CHIP R 100 J 1/10W		
R54			RK73FB2A473J	CHIP R 47K J 1/10W		
R55			RK73FB2A472J	CHIP R 4.7K J 1/10W		
R56			RK73FB2A151J	CHIP R 150 J 1/10W		
R57			RK73FB2A220J	CHIP R 22 J 1/10W		
R58			RK73FB2A750J	CHIP R 75 J 1/10W		
R59 ,60			RK73FB2A100J	CHIP R 10 J 1/10W		
R63			RK73FB2A470J	CHIP R 47 J 1/10W		
VR1			R12-8425-05	TRIMMING POT.(22K)		
D1			SVC212(2,3)	VARIABLE CAPACITANCE DIODE		
D2			1SV239	VARIABLE CAPACITANCE DIODE		
D3			DA204K	DIODE		
IC1			LMX1511TMX	ANALOGUE IC		
IC2			MRFIC2001R2	ANALOGUE IC		
IC3			TK11250AU	ANALOGUE IC		
IC4			NJM2058M	ANALOGUE IC		
IC5			74HCT7046AD	ANALOGUE IC		
IC6			NJM324M	ANALOGUE IC		
IC7			UPC2708T-E3	ANALOGUE IC		
IC8 ,9			UPC2748T-E3	ANALOGUE IC		
Q1			2SC3547A	TRANSISTOR		

L : Scandinavia K : USA P : Canada R : Mexico
Y : PX(Far East, Hawaii) T : Europe E : Europe G : Germany
Y : AAFES(Europe) X : Australia M : Other Areas

⚠ indicates safety critical components.

New Parts
Parts without **Parts No.** are not supplied.
Les articles non mentionnés dans le **Parts No.** ne sont pas fournis.
Teile ohne **Parts No.** werden nicht geliefert.

12

Ref. No	Add-ress	New Parts	Parts No.	Description	Desti-nation	Re-marks
Q3 ,4			2SA1576	TRANSISTOR		
SURROUND UNIT (X08-2720-10)						
C1 ,2			CC73FSL1H101J	CHIP C 100PF J		
C3 ,4			CQ93FMG1H162J	MYLAR 1600PF J		
C5 ,6			CQ93FMG1H123J	MYLAR 0.012UF J		
C9 ,10			CQ93FMG1H222J	MYLAR 2200PF J		
C11 ,12			CQ93FMG1H472J	MYLAR 4700PF J		
C13 ,14			CK73FB1H102K	CHIP C 1000PF K		
C15 ,16			CE04KW1H220M	ELECTRO 22UF 50WV		
C17 ,18			CK73FB1H102K	CHIP C 1000PF K		
C21 ,22			CC73FSL1H101J	CHIP C 100PF J		
C23			CQ93FMG1H162J	MYLAR 1600PF J		
C24			CQ93FMG1H363J	MYLAR 0.036UF J		
C25			CQ93FMG1H123J	MYLAR 0.012UF J		
C26			CQ93FMG1H513J	MYLAR 0.051UF J		
C29			CQ93FMG1H222J	MYLAR 2200PF J		
C30			CQ93FMG1H243J	MYLAR 0.024UF J		
C31 ,32			CQ93FMG1H472J	MYLAR 4700PF J		
C33 ,34			CK73FB1H102K	CHIP C 1000PF K		
C35 ,36			CE04KW1H220M	ELECTRO 22UF 50WV		
C37 ,38			CK73FB1H102K	CHIP C 1000PF K		
C41 ,42			CC73FSL1H101J	CHIP C 100PF J		
C43 ,44			CQ93FMG1H162J	MYLAR 1600PF J		
C45 ,46			CQ93FMG1H123J	MYLAR 0.012UF J		
C49 ,50			CQ93FMG1H222J	MYLAR 2200PF J		
C51 ,52			CQ93FMG1H562J	MYLAR 5600PF J		
C53 ,54			CK73FB1H102K	CHIP C 1000PF K		
C55 ,56			CE04KW1H100M	ELECTRO 10UF 50WV		
C57 ,58			CK73FB1H102K	CHIP C 1000PF K		
C61 -64			CF92FV1H224J	MF-C 0.22UF J		
C65 ,66			CC73FSL1H101J	CHIP C 100PF J		
C67 ,68			CE04KW1H4R7M	ELECTRO 4.7UF 50WV		
C69 -74			CE04KW1E470M	ELECTRO 47UF 25WV		
C75 ,76			CK73FB1H102K	CHIP C 1000PF K		
C77 ,78			CE04KW1E470M	ELECTRO 47UF 25WV		
C79 -82			CK73FB1H102K	CHIP C 1000PF K		
C83 -88			CE04KW1E470M	ELECTRO 47UF 25WV		
C91 -94			CF92FV1H224J	MF-C 0.22UF J		
C95 ,96			CC73FSL1H101J	CHIP C 100PF J		
C97 -100			CE04KW1H4R7M	ELECTRO 4.7UF 50WV		
C101 ,102			CC73FSL1H101J	CHIP C 100PF J		
C103-106			CE04KW1E470M	ELECTRO 47UF 25WV		
C107-110			CK73FB1H102K	CHIP C 1000PF K		
C111 ,112			CE04KW1E470M	ELECTRO 47UF 25WV		
C113 ,114			CC73FSL1H220J	CHIP C 22PF J		
C115 ,116			CC73FSL1H101J	CHIP C 100PF J		
C122			CE04KW1E470M	ELECTRO 47UF 25WV		
C123			CC73FSL1H101J	CHIP C 100PF J		
C124			CQ93FMG1H472J	MYLAR 4700PF J		
C126			CE04KW1E470M	ELECTRO 47UF 25WV		
C127			CE04KW1H4R7M	ELECTRO 4.7UF 50WV		
C128			CC73FSL1H101J	CHIP C 100PF J		
C129			CE04KW1E470M	ELECTRO 47UF 25WV		
C130 ,131			CF92FV1H224J	MF-C 0.22UF J		

L : Scandinavia K : USA P : Canada R : Mexico
Y : PX(Far East, Hawaii) T : Europe E : Europe G : Germany
Y : AAFES(Europe) X : Australia M : Other Areas

⚠ indicates safety critical components.

PARTS LIST

New Parts

Parts without **Parts No.** are not supplied.
Les articles non mentionnés dans le **Parts No.** ne sont pas fournis.
Teile ohne **Parts No.** werden nicht geliefert.

13

Ref. No	Add-ress	New Parts	Parts No.	Description	Desti-nation	Re-marks
C132			CC73FSL1H101J	CHIP C 100PF J		
C133			CE04KW1H4R7M	ELECTRO 4.7UF 50WV		
C134-137			CK73FB1H102K	CHIP C 1000PF K		
C142			CC73FSL1H101J	CHIP C 100PF J		
C143			CK73FB1H332K	CHIP C 3300PF K		
C144			CE04KW1H220M	ELECTRO 22UF 50WV		
C145			CF92FV1H564J	MF-C 0.56UF J		
C146			CF92FV1H274J	MF-C 0.27UF J		
C147			CF92FV1H564J	MF-C 0.56UF J		
C148			CF92FV1H274J	MF-C 0.27UF J		
C149			CE04KW1H220M	ELECTRO 22UF 50WV		
C150			CE04KW1H100M	ELECTRO 10UF 50WV		
C151			CC73FSL1H101J	CHIP C 100PF J		
C152			CE04KW1E470M	ELECTRO 47UF 25WV		
C153,154			CE04KW1H220M	ELECTRO 22UF 50WV		
C155-162			CK73FB1H102K	CHIP C 1000PF K		
C163,164			CQ93FMG1H562J	MYLAR 5600PF J		
C165,166			CK73FF1E104Z	CHIP C 0.10UF Z		
C171			CE04KW1A101M	ELECTRO 100UF 10WV		
C172			CK73FB1H102K	CHIP C 1000PF K		
C173			CK73FF1E104Z	CHIP C 0.10UF Z		
C175			C90-3270-05	ELECTRO 100UF 10WV		
C176			CC73FSL1H101J	CHIP C 100PF J		
C177-180			CC73FSL1H220J	CHIP C 22PF J		
C181			CK73FB1H102K	CHIP C 1000PF K		
C182			CC73FSL1H470J	CHIP C 47PF J		
C191			C90-3270-05	ELECTRO 100UF 10WV		
C192			CK73FB1H102K	CHIP C 1000PF K		
C193			CK73FF1E104Z	CHIP C 0.10UF Z		
C195			CE04KW1A101M	ELECTRO 100UF 10WV		
C196			CK73FB1H102K	CHIP C 1000PF K		
C197-200			CC73FSL1H220J	CHIP C 22PF J		
C201			CK73FB1H102K	CHIP C 1000PF K		
C202			CC73FSL1H470J	CHIP C 47PF J		
C206-208			CK73FB1H102K	CHIP C 1000PF K		
C209-211			CE04KW1A101M	ELECTRO 100UF 10WV		
C212			CK73FB1H102K	CHIP C 1000PF K		
C213			CK73FF1E104Z	CHIP C 0.10UF Z		
C214			CK73FB1H103K	CHIP C 0.010UF K		
C228,229			CC73FSL1H220J	CHIP C 22PF J		
C231			CE04KW1A101M	ELECTRO 100UF 10WV		
C232,233			CK73FB1H102K	CHIP C 1000PF K		
C234			CC73FSL1H150J	CHIP C 15PF J		
C235			CF92FV1H105J	MF-C 1.0UF J		
C236			CK73FF1E104Z	CHIP C 0.10UF Z		
C237			CE04KW1A101M	ELECTRO 100UF 10WV		
C238			CK73FB1H102K	CHIP C 1000PF K		
C239			CC73FSL1H101J	CHIP C 100PF J		
C240			CC73FSL1H220J	CHIP C 22PF J		
C241-246			CE04KW1H4R7M	ELECTRO 4.7UF 50WV		
C247,248			CE04KW1H220M	ELECTRO 22UF 50WV		
C249,250			CE04KW1A101M	ELECTRO 100UF 10WV		
C251,252			CE04KW1E470M	ELECTRO 47UF 25WV		
C253,254			CE04KW1H4R7M	ELECTRO 4.7UF 50WV		
C255-258			CK73FF1E104Z	CHIP C 0.10UF Z		

L : Scandinavia K : USA P : Canada R : Mexico
Y : PX(Far East, Hawaii) T : Europe E : Europe G : Germany
Y : AAFES(Europe) X : Australia M : Other Areas

⚠ indicates safety critical components.

New Parts

Parts without **Parts No.** are not supplied.
Les articles non mentionnés dans le **Parts No.** ne sont pas fournis.
Teile ohne **Parts No.** werden nicht geliefert.

14

Ref. No	Add-ress	New Parts	Parts No.	Description	Desti-nation	Re-marks
C261-266			CE04KW1H4R7M	ELECTRO 4.7UF 50WV		
C267,268			CE04KW1H220M	ELECTRO 22UF 50WV		
C269,270			CE04KW1A101M	ELECTRO 100UF 10WV		
C271,272			CE04KW1E470M	ELECTRO 47UF 25WV		
C273,274			CE04KW1H4R7M	ELECTRO 4.7UF 50WV		
C275-278			CK73FF1E104Z	CHIP C 0.10UF Z		
C279,280			CE04KW1E470M	ELECTRO 47UF 25WV		
C281-286			CE04KW1H4R7M	ELECTRO 4.7UF 50WV		
C287,288			CE04KW1H220M	ELECTRO 22UF 50WV		
C289,290			CE04KW1A101M	ELECTRO 100UF 10WV		
C291,292			CE04KW1E470M	ELECTRO 47UF 25WV		
C293,294			CE04KW1H4R7M	ELECTRO 4.7UF 50WV		
C295-298			CK73FF1E104Z	CHIP C 0.10UF Z		
C301,302			CE04KW1H220M	ELECTRO 22UF 50WV		
C307,308			CC73FSL1H331J	CHIP C 330PF J		
C309,310			CE04KW1H100M	ELECTRO 10UF 50WV		
C311,312			CQ93FMG1H152J	MYLAR 1500PF J		
C313-316			CK73FB1H102K	CHIP C 1000PF K		
C317			CE04KW1A101M	ELECTRO 100UF 10WV		
C318			CK73FF1E104Z	CHIP C 0.10UF Z		
C319			CE04KW1H4R7M	ELECTRO 4.7UF 50WV		
C320,321			CK73FB1H102K	CHIP C 1000PF K		
C322,323			CE04KW1H100M	ELECTRO 10UF 50WV		
C324			CK73FF1E104Z	CHIP C 0.10UF Z		
C325			CK73FB1H102K	CHIP C 1000PF K		
C326-328			CC73FSL1H220J	CHIP C 22PF J		
C329			CE04KW1A101M	ELECTRO 100UF 10WV		
C330			CK73FB1H102K	CHIP C 1000PF K		
C331			CE04KW1A101M	ELECTRO 100UF 10WV		
C332			CK73FB1H102K	CHIP C 1000PF K		
C333			CK73FF1E104Z	CHIP C 0.10UF Z		
C334,335			CC73FCH1H050C	CHIP C 5.0PF C		
C336-338			CC73FSL1H220J	CHIP C 22PF J		
C339			CK73FB1H103K	CHIP C 0.010UF K		
C340			CK73FB1H102K	CHIP C 1000PF K		
C341			CE04KW1A101M	ELECTRO 100UF 10WV		
C342			CK73FB1H102K	CHIP C 1000PF K		
C343			CE04KW1A101M	ELECTRO 100UF 10WV		
C344,345			CK73FB1H103K	CHIP C 0.010UF K		
C346			CE04KW1A101M	ELECTRO 100UF 10WV		
C347,348			CK73FF1E104Z	CHIP C 0.10UF Z		
C351-354			CC73FSL1H101J	CHIP C 100PF J		
C355			CK73FF1E104Z	CHIP C 0.10UF Z		
C356			CF92FV1H224J	MF-C 0.22UF J		
C357-359			CK73FF1E104Z	CHIP C 0.10UF Z		
C360			CK73FB1H103K	CHIP C 0.010UF K		
C361			CE04KW1A470M	ELECTRO 47UF 10WV		
C362			CK73FB1H103K	CHIP C 0.010UF K		
C363			CE04KW1A470M	ELECTRO 47UF 10WV		
C364			CK73FB1H103K	CHIP C 0.010UF K		
C365			CE04KW1A470M	ELECTRO 47UF 10WV		
C366			CK73FB1H103K	CHIP C 0.010UF K		
C367			CE04KW1A470M	ELECTRO 47UF 10WV		
C368			CK73FB1H103K	CHIP C 0.010UF K		
C369			CE04KW1A470M	ELECTRO 47UF 10WV		

L : Scandinavia K : USA P : Canada R : Mexico
Y : PX(Far East, Hawaii) T : Europe E : Europe G : Germany
Y : AAFES(Europe) X : Australia M : Other Areas

⚠ indicates safety critical components.

PARTS LIST

New Parts
Parts without **Parts No.** are not supplied.
Les articles non mentionnés dans le **Parts No.** ne sont pas fournis.
Teile ohne **Parts No.** werden nicht geliefert.

15

Ref. No	Add-ress	New Parts	Parts No.	Description	Desti-nation	Re-marks
C370			CK73FB1H103K	CHIP C 0.010UF K		
C371-374			CC73FSL1H390J	CHIP C 39PF J		
C375			CK73FF1E104Z	CHIP C 0.10UF Z		
C376,377			CK73FB1H103K	CHIP C 0.010UF K		
C378-380			CC73FSL1H470J	CHIP C 47PF J		
C381			CK73FB1H103K	CHIP C 0.010UF K		
C382			CC73FSL1H470J	CHIP C 47PF J		
C383,384			CE04KW1A101M	ELECTRO 100UF 10WV		
C385			CK73FF1E104Z	CHIP C 0.10UF Z		
C386			CE04KW1A101M	ELECTRO 100UF 10WV		
C387			CK73FF1E104Z	CHIP C 0.10UF Z		
C388			CC73FSL1H221J	CHIP C 220PF J		
C389			CC73FSL1H101J	CHIP C 100PF J		
C391,392			CK73FB1H103K	CHIP C 0.010UF K		
C393,394			CF92FV1H474J	MF-C 0.47UF J		
C395			CE04HW1A470M	NP-ELEC 47UF 10WV		
C396			CK73FB1H103K	CHIP C 0.010UF K		
C397,398			CE04KW1A101M	ELECTRO 100UF 10WV		
C399			CC73FSL1H150J	CHIP C 15PF J		
C400,401			CE04KW1A101M	ELECTRO 100UF 10WV		
C402-404			CK73FB1H103K	CHIP C 0.010UF K		
C405			CE04KW1A101M	ELECTRO 100UF 10WV		
C406-408			CK73FB1H103K	CHIP C 0.010UF K		
C409			CE04KW1A101M	ELECTRO 100UF 10WV		
C410-412			CK73FF1E104Z	CHIP C 0.10UF Z		
C413-415			CE04KW1A101M	ELECTRO 100UF 10WV		
C416			CK73FB1H103K	CHIP C 0.010UF K		
C417,418			CC73FSL1H220J	CHIP C 22PF J		
C419			CC73FSL1H101J	CHIP C 100PF J		
C420			CC73FSL1H100D	CHIP C 10PF D		
C421			CC73FSL1H221J	CHIP C 220PF J		
C422			CK73FB1H102K	CHIP C 1000PF K		
C423			CK73FF1E104Z	CHIP C 0.10UF Z		
C424			CK73FB1H102K	CHIP C 1000PF K		
C425,426			CK73FF1E104Z	CHIP C 0.10UF Z		
C427			CK73FB1H103K	CHIP C 0.010UF K		
C428,429			CK73FF1E104Z	CHIP C 0.10UF Z		
C431-434			CC73FSL1H470J	CHIP C 47PF J		
C435-438			CC73FSL1H220J	CHIP C 22PF J		
C439			CE04KW1A101M	ELECTRO 100UF 10WV		
C440			CK73FF1E104Z	CHIP C 0.10UF Z		
C441,442			CE04KW1A101M	ELECTRO 100UF 10WV		
C443,444			CK73FF1E104Z	CHIP C 0.10UF Z		
C445,446			CE04KW1A471M	ELECTRO 470UF 10WV		
C447-452			CE04KW1A101M	ELECTRO 100UF 10WV		
C453,454			CE04KW1A471M	ELECTRO 470UF 10WV		
C455,456			CC73FCH1H050C	CHIP C 5.0PF C		
C457,458			CC73FSL1H100D	CHIP C 10PF D		
C459,460			CC73FSL1H220J	CHIP C 22PF J		
C461			CK73FF1E104Z	CHIP C 0.10UF Z		
C462			CC73FSL1H221J	CHIP C 220PF J		
C463-466			CK73FF1E104Z	CHIP C 0.10UF Z		
C467			CK73FB1H103K	CHIP C 0.010UF K		
C468			CC73FSL1H220J	CHIP C 22PF J		
C469			CE04KW1A101M	ELECTRO 100UF 10WV		

L : Scandinavia K : USA P : Canada R : Mexico
Y : PX(Far East, Hawaii) T : Europe E : Europe G : Germany
Y : AAFES(Europe) X : Australia M : Other Areas

△ indicates safety critical components.

New Parts
Parts without **Parts No.** are not supplied.
Les articles non mentionnés dans le **Parts No.** ne sont pas fournis.
Teile ohne **Parts No.** werden nicht geliefert.

16

Ref. No	Add-ress	New Parts	Parts No.	Description	Desti-nation	Re-marks
C501-522			CK73FF1E104Z	CHIP C 0.10UF Z		
C523			CK73FB1H102K	CHIP C 1000PF K		
C524			CE04KW1A101M	ELECTRO 100UF 10WV		
C525			CK73FB1H102K	CHIP C 1000PF K		
C526			CE04KW1A101M	ELECTRO 100UF 10WV		
C527			CK73FB1H102K	CHIP C 1000PF K		
C528			CK73FF1E104Z	CHIP C 0.10UF Z		
C529-531			CC73FSL1H220J	CHIP C 22PF J		
C532			CE04KW1A101M	ELECTRO 100UF 10WV		
C533			CK73FB1H103K	CHIP C 0.010UF K		
C534-538			CK73FF1E104Z	CHIP C 0.10UF Z		
C539			CE04KW1A101M	ELECTRO 100UF 10WV		
C541			CK73FF1E104Z	CHIP C 0.10UF Z		
C542			CK73FB1H102K	CHIP C 1000PF K		
C543			CK73FF1E104Z	CHIP C 0.10UF Z		
C544,545			CK73FB1H102K	CHIP C 1000PF K		
C546,547			CC73FSL1H221J	CHIP C 220PF J		
C548			CC73FSL1H470J	CHIP C 47PF J		
C549			CC73FSL1H220J	CHIP C 22PF J		
C550-552			CC73FSL1H470J	CHIP C 47PF J		
C553			CK73FB1H102K	CHIP C 1000PF K		
C554			CK73FF1E104Z	CHIP C 0.10UF Z		
C555			CE04KW1A101M	ELECTRO 100UF 10WV		
C556			CK73FB1H102K	CHIP C 1000PF K		
C557			CK73FF1E104Z	CHIP C 0.10UF Z		
C558			C90-3270-05	ELECTRO 100UF 10WV		
C559			CK73FF1E104Z	CHIP C 0.10UF Z		
C560			CK73FB1H102K	CHIP C 1000PF K		
C561			CK73FF1E104Z	CHIP C 0.10UF Z		
C562,563			CK73FB1H102K	CHIP C 1000PF K		
C564,565			CC73FSL1H221J	CHIP C 220PF J		
C566			CC73FSL1H470J	CHIP C 47PF J		
C567			CK73FB1H102K	CHIP C 1000PF K		
C568			CK73FF1E104Z	CHIP C 0.10UF Z		
C569			C90-3270-05	ELECTRO 100UF 10WV		
C570			CK73FB1H102K	CHIP C 1000PF K		
C571			CK73FF1E104Z	CHIP C 0.10UF Z		
C572			CE04KW1A101M	ELECTRO 100UF 10WV		
C573-579			CK73FB1H102K	CHIP C 1000PF K		
C581			CK73FB1H103K	CHIP C 0.010UF K		
C582-584			CE04KW1A101M	ELECTRO 100UF 10WV		
C585			CK73FB1H103K	CHIP C 0.010UF K		
C586			CE04KW1A101M	ELECTRO 100UF 10WV		
C587			CK73FB1H103K	CHIP C 0.010UF K		
C588			CE04KW1A101M	ELECTRO 100UF 10WV		
C589			CK73FB1H103K	CHIP C 0.010UF K		
C590			CC73FSL1H220J	CHIP C 22PF J		
CN1			E40-4159-05	FLAT CABLE CONNECTOR		
CN2			E40-4293-05	FLAT CABLE CONNECTOR		
CN3			E40-4808-05	PIN ASSY		
J1,2			E63-0174-05	PHONO JACK		
J3			E63-0179-05	PHONO JACK		
L1			L79-0788-05	LC FILTER		
L11 -26			L92-0044-05	FERRITE CORE		

L : Scandinavia K : USA P : Canada R : Mexico
Y : PX(Far East, Hawaii) T : Europe E : Europe G : Germany
Y : AAFES(Europe) X : Australia M : Other Areas

△ indicates safety critical components.

PARTS LIST

New Parts
Parts without **Parts No.** are not supplied.
Les articles non mentionnés dans le **Parts No.** ne sont pas fournis.
Teile ohne **Parts No.** werden nicht geliefert.

17

Ref. No	Add-ress	New Parts	Parts No.	Description	Desti-nation	Re-marks
L31 -33			L92-0044-05	FERRITE CORE		
L41			L92-0044-05	FERRITE CORE		
L43 -52			L92-0044-05	FERRITE CORE		
L61 -66			L92-0044-05	FERRITE CORE		
L71 -76			L92-0044-05	FERRITE CORE		
L81 -91			L92-0044-05	FERRITE CORE		
L101-118			L92-0044-05	FERRITE CORE		
L121,122			L92-0044-05	FERRITE CORE		
L131,132			L92-0044-05	FERRITE CORE		
X1			L77-2143-05	CRYSTAL RESONATOR(24.576MHZ(LC		
X2			L78-0267-05	RESONATOR (4.194MHZ)		
R1 ,2			RK73FB2A432J	CHIP R 4.3K J 1/10W		
R3 ,4			RK73FB2A911J	CHIP R 910 J 1/10W		
R5 ,6			RK73FB2A101J	CHIP R 100 J 1/10W		
R7 ,8			RK73FB2A152J	CHIP R 1.5K J 1/10W		
R9 ,10			RK73FB2A821J	CHIP R 820 J 1/10W		
R11 ,12			RK73FB2A103J	CHIP R 10K J 1/10W		
R13 ,14			RK73FB2A471J	CHIP R 470 J 1/10W		
R15 -18			RK73FB2A473J	CHIP R 47K J 1/10W		
R21 ,22			RK73FB2A432J	CHIP R 4.3K J 1/10W		
R23			RK73FB2A911J	CHIP R 910 J 1/10W		
R24			RK73FB2A392J	CHIP R 3.9K J 1/10W		
R25 ,26			RK73FB2A101J	CHIP R 100 J 1/10W		
R27			RK73FB2A152J	CHIP R 1.5K J 1/10W		
R28			RK73FB2A392J	CHIP R 3.9K J 1/10W		
R29			RK73FB2A821J	CHIP R 820 J 1/10W		
R31			RK73FB2A103J	CHIP R 10K J 1/10W		
R33 ,34			RK73FB2A471J	CHIP R 470 J 1/10W		
R41 ,42			RK73FB2A432J	CHIP R 4.3K J 1/10W		
R43 ,44			RK73FB2A911J	CHIP R 910 J 1/10W		
R45 ,46			RK73FB2A101J	CHIP R 100 J 1/10W		
R47 ,48			RK73FB2A152J	CHIP R 1.5K J 1/10W		
R49 ,50			RK73FB2A821J	CHIP R 820 J 1/10W		
R51 ,52			RK73FB2A103J	CHIP R 10K J 1/10W		
R53 ,54			RK73FB2A471J	CHIP R 470 J 1/10W		
R61 ,62			RK73FB2A104J	CHIP R 100K J 1/10W		
R63 ,64			RK73FB2A133J	CHIP R 13K J 1/10W		
R65 ,66			RK73FB2A622J	CHIP R 6.2K J 1/10W		
R67 ,68			RK73FB2A104J	CHIP R 100K J 1/10W		
R81 ,82			RK73FB2A104J	CHIP R 100K J 1/10W		
R83 ,84			RK73FB2A133J	CHIP R 13K J 1/10W		
R85 ,86			RK73FB2A622J	CHIP R 6.2K J 1/10W		
R87 ,88			RK73FB2A104J	CHIP R 100K J 1/10W		
R101,102			RK73FB2A104J	CHIP R 100K J 1/10W		
R103,104			RK73FB2A123J	CHIP R 12K J 1/10W		
R105,106			RK73FB2A203J	CHIP R 20K J 1/10W		
R107,108			RK73FB2A123J	CHIP R 12K J 1/10W		
R109,110			RK73FB2A203J	CHIP R 20K J 1/10W		
R113,114			RK73FB2A123J	CHIP R 12K J 1/10W		
R115,116			RK73FB2A222J	CHIP R 2.2K J 1/10W		
R119,120			RK73FB2A222J	CHIP R 2.2K J 1/10W		
R131			RK73FB2A104J	CHIP R 100K J 1/10W		
R132,133			RK73FB2A473J	CHIP R 47K J 1/10W		
R134			RK73FB2A622J	CHIP R 6.2K J 1/10W		

L : Scandinavia K : USA P : Canada R : Mexico
Y : PX(Far East, Hawaii) T : Europe E : Europe G : Germany
Y : AAFES(Europe) X : Australia M : Other Areas

△ indicates safety critical components.

New Parts
Parts without **Parts No.** are not supplied.
Les articles non mentionnés dans le **Parts No.** ne sont pas fournis.
Teile ohne **Parts No.** werden nicht geliefert.

18

Ref. No	Add-ress	New Parts	Parts No.	Description	Desti-nation	Re-marks
R135			RK73FB2A133J	CHIP R 13K J 1/10W		
R136			RK73FB2A472J	CHIP R 4.7K J 1/10W		
R137-142			RK73FB2A104J	CHIP R 100K J 1/10W		
R143			RK73FB2A753J	CHIP R 75K J 1/10W		
R144			RK73FB2A472J	CHIP R 4.7K J 1/10W		
R145			RK73FB2A473J	CHIP R 47K J 1/10W		
R146			RK73FB2A104J	CHIP R 100K J 1/10W		
R147			RK73FB2A272J	CHIP R 2.7K J 1/10W		
R148			RK73FB2A473J	CHIP R 47K J 1/10W		
R149,150			RK73FB2A512J	CHIP R 5.1K J 1/10W		
R151			RK73FB2A104J	CHIP R 100K J 1/10W		
R152,153			RK73FB2A512J	CHIP R 5.1K J 1/10W		
R154-159			RK73FB2A104J	CHIP R 100K J 1/10W		
R160,161			RK73FB2A472J	CHIP R 4.7K J 1/10W		
R162			RK73FB2A243J	CHIP R 24K J 1/10W		
R201-220			RK73FB2A470J	CHIP R 47 J 1/10W		
R221			RK73FB2A243J	CHIP R 24K J 1/10W		
R222			RK73FB2A621J	CHIP R 620 J 1/10W		
R223			RK73FB2A222J	CHIP R 2.2K J 1/10W		
R224			RK73FB2A221J	CHIP R 220 J 1/10W		
R226			RK73FB2A470J	CHIP R 47 J 1/10W		
R227			RK73FB2A102J	CHIP R 1.0K J 1/10W		
R228			RK73FB2A470J	CHIP R 47 J 1/10W		
R229			RK73FB2A102J	CHIP R 1.0K J 1/10W		
R230-232			RK73FB2A471J	CHIP R 470 J 1/10W		
△ R233			RS14DB3D390J	FL-PROOF RS 39 J 2W		
△ R234,235			RS14DB3D470J	FL-PROOF RS 47 J 2W		
△ R237,238			RK73FB2A470J	CHIP R 47 J 1/10W		
△ R240,241			RS14DB3D470J	FL-PROOF RS 47 J 2W		
△ R242			RS14DB3D390J	FL-PROOF RS 39 J 2W		
R243			RK73FB2A470J	CHIP R 47 J 1/10W		
R244			RS14DB3D390J	FL-PROOF RS 39 J 2W		
R251,252			RK73FB2A332J	CHIP R 3.3K J 1/10W		
R261,262			RK73FB2A242J	CHIP R 2.4K J 1/10W		
R267,268			RK73FB2A221J	CHIP R 220 J 1/10W		
R269-272			RK73FB2A331J	CHIP R 330 J 1/10W		
R273			RK73FB2A512J	CHIP R 5.1K J 1/10W		
R274			RK73FB2A472J	CHIP R 4.7K J 1/10W		
R275			RK73FB2A511J	CHIP R 510 J 1/10W		
R276			RK73FB2A471J	CHIP R 470 J 1/10W		
R277			RK73FB2A103J	CHIP R 10K J 1/10W		
R290			RK73FB2A471J	CHIP R 470 J 1/10W		
R291			RK73FB2A220J	CHIP R 22 J 1/10W		
R292			RK73FB2A105J	CHIP R 1.0M J 1/10W		
R293-297			RK73FB2A221J	CHIP R 220 J 1/10W		
R298			RK73FB2A750J	CHIP R 75 J 1/10W		
R299			RK73FB2A150J	CHIP R 15 J 1/10W		
R300			RK73FB2A750J	CHIP R 75 J 1/10W		
R301			RK73FB2A331J	CHIP R 330 J 1/10W		
R302-304			RK73FB2A750J	CHIP R 75 J 1/10W		
R305,306			RK73FB2A472J	CHIP R 4.7K J 1/10W		
R307,308			RK73FB2A471J	CHIP R 470 J 1/10W		
R310			RK73FB2A472J	CHIP R 4.7K J 1/10W		
R311-314			RK73FB2A103J	CHIP R 10K J 1/10W		
R315			RK73FB2A750J	CHIP R 75 J 1/10W		

L : Scandinavia K : USA P : Canada R : Mexico
Y : PX(Far East, Hawaii) T : Europe E : Europe G : Germany
Y : AAFES(Europe) X : Australia M : Other Areas

△ indicates safety critical components.

PARTS LIST

New Parts
Parts without **Parts No.** are not supplied.
Les articles non mentionnés dans le **Parts No.** ne sont pas fournis.
Teile ohne **Parts No.** werden nicht geliefert.

19

Ref. No	Add-ress	New Parts	Parts No.	Description	Desti-nation	Re-marks
R316,317			RK73FB2A202J	CHIP R 2.0K J 1/10W		
R318			RK73FB2A681J	CHIP R 680 J 1/10W		
R319			RK73FB2A102J	CHIP R 1.0K J 1/10W		
R320			RK73FB2A103J	CHIP R 10K J 1/10W		
R321			RK73FB2A202J	CHIP R 2.0K J 1/10W		
R322			RK73FB2A103J	CHIP R 10K J 1/10W		
R323,324			RK73FB2A102J	CHIP R 1.0K J 1/10W		
R325,326			RK73FB2A202J	CHIP R 2.0K J 1/10W		
R327			RK73FB2A681J	CHIP R 680 J 1/10W		
R328			RK73FB2A102J	CHIP R 1.0K J 1/10W		
R329			RK73FB2A103J	CHIP R 10K J 1/10W		
R330			RK73FB2A202J	CHIP R 2.0K J 1/10W		
R331			RK73FB2A222J	CHIP R 2.2K J 1/10W		
R332,333			RK73FB2A104J	CHIP R 100K J 1/10W		
R334			RK73FB2A103J	CHIP R 10K J 1/10W		
R335			RK73FB2A224J	CHIP R 220K J 1/10W		
R336			RK73FB2A821J	CHIP R 820 J 1/10W		
R337			RK73FB2A224J	CHIP R 220K J 1/10W		
R340			RK73FB2A121J	CHIP R 120 J 1/10W		
R341			RK73FB2A473J	CHIP R 47K J 1/10W		
R342			RK73FB2A101J	CHIP R 100 J 1/10W		
R350,351			RK73FB2A473J	CHIP R 47K J 1/10W		
R352-354			RK73FB2A103J	CHIP R 10K J 1/10W		
R355			RK73FB2A100J	CHIP R 10 J 1/10W		
R356-358			RK73FB2A103J	CHIP R 10K J 1/10W		
R360			RK73FB2A472J	CHIP R 4.7K J 1/10W		
R362,363			RK73FB2A103J	CHIP R 10K J 1/10W		
R371			RK73FB2A333J	CHIP R 33K J 1/10W		
R372			RK73FB2A103J	CHIP R 10K J 1/10W		
R373			RK73FB2A243J	CHIP R 24K J 1/10W		
R374,375			RK73FB2A562J	CHIP R 5.6K J 1/10W		
R376			RK73FB2A151J	CHIP R 150 J 1/10W		
R377-379			RK73FB2A101J	CHIP R 100 J 1/10W		
R380			RK73FB2A471J	CHIP R 470 J 1/10W		
R381-387			RK73FB2A102J	CHIP R 1.0K J 1/10W		
R388-390			RK73FB2A563J	CHIP R 56K J 1/10W		
R391			RK73FB2A100J	CHIP R 10 J 1/10W		
R392,393			RK73FB2A102J	CHIP R 1.0K J 1/10W		
R394-397			RK73FB2A470J	CHIP R 47 J 1/10W		
R398,399			RK73FB2A102J	CHIP R 1.0K J 1/10W		
R401,402			RK73FB2A103J	CHIP R 10K J 1/10W		
R403,404			RK73FB2A102J	CHIP R 1.0K J 1/10W		
R405			RK73FB2A101J	CHIP R 100 J 1/10W		
R406			RK73FB2A103J	CHIP R 10K J 1/10W		
R421-427			RK73FB2A470J	CHIP R 47 J 1/10W		
R428,429			RK73FB2A103J	CHIP R 10K J 1/10W		
R430			RS14DB3D270J	FL-PROOF RS 27 J 2W		
R431,432			RK73FB2A470J	CHIP R 47 J 1/10W		
R433-435			RS14DB3D270J	FL-PROOF RS 27 J 2W		
R436-439			RS14DB3D390J	FL-PROOF RS 39 J 2W		
R440-442			RK73FB2A471J	CHIP R 470 J 1/10W		
R443			RK73FB2A470J	CHIP R 47 J 1/10W		
R444,445			RK73FB2A472J	CHIP R 4.7K J 1/10W		
R446-448			RK73FB2A102J	CHIP R 1.0K J 1/10W		
R449			RS14DB3D270J	FL-PROOF RS 27 J 2W		

L : Scandinavia K : USA P : Canada R : Mexico
Y : PX(Far East, Hawaii) T : Europe E : Europe G : Germany
Y : AAFES(Europe) X : Australia M : Other Areas

△ indicates safety critical components.

New Parts
Parts without **Parts No.** are not supplied.
Les articles non mentionnés dans le **Parts No.** ne sont pas fournis.
Teile ohne **Parts No.** werden nicht geliefert.

20

Ref. No	Add-ress	New Parts	Parts No.	Description	Desti-nation	Re-marks
R451			RK73FB2A101J	CHIP R 100 J 1/10W		
R454-456			RK73FB2A101J	CHIP R 100 J 1/10W		
R459,460			RK73FB2A101J	CHIP R 100 J 1/10W		
R462-491			RK73FB2A101J	CHIP R 100 J 1/10W		
R492-529			RK73FB2A104J	CHIP R 100K J 1/10W		
R530			RK73FB2A223J	CHIP R 22K J 1/10W		
R531-558			RK73FB2A104J	CHIP R 100K J 1/10W		
R559-564			RK73FB2A101J	CHIP R 100 J 1/10W		
R565-582			RK73FB2A470J	CHIP R 47 J 1/10W		
R583,584			RK73FB2A103J	CHIP R 10K J 1/10W		
D1 -8			DAN202U	DIODE		
D10 -22			DAN202U	DIODE		
D23 ,24			U1BC44	DIODE		
D31			HZS8.2S(B2)	ZENER DIODE		
D31			RD8.2JS(B2)	ZENER DIODE		
D51 ,52			DAN202U	DIODE		
IC1 -9			NJM4580E	ANALOGUE IC		
IC11-16			NJM4580E	ANALOGUE IC		
IC17			TC9162AF	MOS-IC		
IC18			TC9163AF	MOS-IC		
IC21-26			PCM1702U	MOS-IC		
IC27-29			SM5841HS	MOS-IC		
IC30,31			KAN02	CUSTOM IC		
IC32			TC9246F	ANALOGUE IC		
IC33			TLC2932IPW	MOS-IC		
IC38			TC74HCU04AF	IC(HEX INVERTER SMD)		
IC39,40			NJM4580E	ANALOGUE IC		
IC41,42			LC83015JE	MOS-IC		
IC43-46			LC32464P-80	MEMORY IC		
IC47			ZR38500-36	MOS-IC		
IC48,49			TC55B329J-12	MEMORY IC		
IC50			78P058GC1ACB	MI-COM IC		
IC51			NJM4580E	ANALOGUE IC		
IC52			TC74HCU04AF	IC(HEX INVERTER SMD)		
IC61,62			M5238AL	IC(OP AMP X2)		
IC63			AK5340-VS	MOS-IC		
IC64			TC74HCU04AF	IC(HEX INVERTER SMD)		
IC65			TC74HC74AF	IC(DUAL D-TYPE FLIP FLOP)		
IC66-68			TC74HCU04AF	IC(HEX INVERTER SMD)		
IC69			TC74HC153AF	MOS-IC		
IC71			TC74HCU04AF	IC(HEX INVERTER SMD)		
IC73			NJM4580E	ANALOGUE IC		
IC75			PD4606A	MOS-IC		
IC76			TC55329AJ-25	MEMORY IC		
IC76			TC55329AJ-35	MEMORY IC		
IC77			LC8904Q	MOS-IC		
IC78			TC74HC157AF	MOS-IC		
IC79			TC74HCU04AF	IC(HEX INVERTER SMD)		
△ IC80,81			TA7805S	IC(VOLTAGE REGULATOR/ +5V)		
△ IC80,81			UPC7805AHF	IC(VOLTAGE REGULATOR/ +5V)		
△ IC82			TA79005S	IC(VOLTAGE REGULATOR/ -5V)		
△ IC82			UPC7905HF	IC(VOLTAGE REGULATOR/ -5V)		
△ IC83-85			TA7805S	IC(VOLTAGE REGULATOR/ +5V)		
△ IC83-85			UPC7805AHF	IC(VOLTAGE REGULATOR/ +5V)		
Q1 ,2			2SC3940A(R,S)	TRANSISTOR		

L : Scandinavia K : USA P : Canada R : Mexico
Y : PX(Far East, Hawaii) T : Europe E : Europe G : Germany
Y : AAFES(Europe) X : Australia M : Other Areas

△ indicates safety critical components.

PARTS LIST

New Parts
Parts without **Parts No.** are not supplied.
Les articles non mentionnés dans le **Parts No.** ne sont pas fournis.
Teile ohne **Parts No.** werden nicht geliefert.

21

Ref. No	Add-ress	New Parts	Parts No.	Description	Desti-nation	Re-marks
Q3			2SA1534A(R,S)	TRANSISTOR		
Q8			2SC1845(F,E)	TRANSISTOR		
Q9			2SA992(F,E)	TRANSISTOR		
Q10			2SD882	TRANSISTOR		
Q11 ,12			2SC1923(R,O)	TRANSISTOR		
Q13			2SA992(F,E)	TRANSISTOR		
Q14 -16			2SC1923(R,O)	TRANSISTOR		
Q17 ,18			2SA992(F,E)	TRANSISTOR		
Q19			DTA113ZS	DIGITAL TRANSISTOR		
Q19			UN4119	DIGITAL TRANSISTOR		
△ Q21			2SD2012	TRANSISTOR		
△ Q21			2SD2061	TRANSISTOR		
△ Q22 ,23			2SC3940A(R,S)	TRANSISTOR		
A1 -4			W02-1181-05	OPTIC RECEIVING MODULE		
A5			W02-1114-05	OSCILLATING MODULE		
A11			W02-2544-05	OSCILLATING MODULE		
A12			W02-2560-05	OSCILLATING MODULE		
A21			W02-2545-05	OSCILLATING MODULE		
AUDIO UNIT (X09-4330-10)						
C1 -6			CC73FSL1H101J	CHIP C	100PF	J
C9 ,10			CE04KW1V4R7M	ELECTRO	4.7UF	35WV
C11 ,12			CE04KW1H2R2M	ELECTRO	2.2UF	50WV
C13 ,14			CC73FSL1H270J	CHIP C	27PF	J
C15 ,16			CC73FSL1H101J	CHIP C	100PF	J
C17 ,18			CC73FSL1H470J	CHIP C	47PF	J
C19 ,20			CE04KW1V4R7M	ELECTRO	4.7UF	35WV
C21 ,22			CE04KW1H100M	ELECTRO	10UF	50WV
C23 ,24			CC73FSL1H270J	CHIP C	27PF	J
C25 -28			CC73FSL1H101J	CHIP C	100PF	J
C29 -32			CE04KW1HR33M	ELECTRO	0.33UF	50WV
C33 -36			CQ93FMG1H223J	MYLAR	0.022UF	J
C37 ,38			CE04KW1H100M	ELECTRO	10UF	50WV
C41 ,42			CE04KW1HR33M	ELECTRO	0.33UF	50WV
C43 ,44			CE04KW1H010M	ELECTRO	1.0UF	50WV
C45 ,46			CC73FSL1H270J	CHIP C	27PF	J
C47 ,48			CC73FSL1H101J	CHIP C	100PF	J
C49 ,50			CE04KW1V330M	ELECTRO	33UF	35WV
C61 ,62			CC73FSL1H151J	CHIP C	150PF	J
C63 -68			CC73FSL1H101J	CHIP C	100PF	J
C71 ,72			CE04KW1V4R7M	ELECTRO	4.7UF	35WV
C73 ,74			CE04KW1H2R2M	ELECTRO	2.2UF	50WV
C75 ,76			CC73FSL1H270J	CHIP C	27PF	J
C77 ,78			CC73FSL1H101J	CHIP C	100PF	J
C79 ,80			CC73FSL1H470J	CHIP C	47PF	J
C81 ,82			CE04KW1V4R7M	ELECTRO	4.7UF	35WV
C83 ,84			CE04KW1H100M	ELECTRO	10UF	50WV
C85 ,86			CC73FSL1H270J	CHIP C	27PF	J
C87 -90			CC73FSL1H101J	CHIP C	100PF	J
C91 -94			CE04KW1HR33M	ELECTRO	0.33UF	50WV
C95 -98			CQ93FMG1H223J	MYLAR	0.022UF	J
C99 ,100			CE04KW1H010M	ELECTRO	1.0UF	50WV
C105,106			CE04KW1H3R3M	ELECTRO	3.3UF	50WV
C107,108			CC73FSL1H270J	CHIP C	27PF	J
C109,110			CC73FSL1H101J	CHIP C	100PF	J

L : Scandinavia K : USA P : Canada R : Mexico
Y : PX(Far East, Hawaii) T : Europe E : Europe G : Germany
Y : AAFES(Europe) X : Australia M : Other Areas

△ indicates safety critical components.

New Parts
Parts without **Parts No.** are not supplied.
Les articles non mentionnés dans le **Parts No.** ne sont pas fournis.
Teile ohne **Parts No.** werden nicht geliefert.

22

Ref. No	Add-ress	New Parts	Parts No.	Description	Desti-nation	Re-marks
C111,112			CE04KW1V330M	ELECTRO	33UF	35WV
C113,114			CC73FSL1H151J	CHIP C	150PF	J
C115-120			CC73FSL1H101J	CHIP C	100PF	J
C123,124			CE04KW1V4R7M	ELECTRO	4.7UF	35WV
C125,126			CE04KW1H2R2M	ELECTRO	2.2UF	50WV
C127,128			CC73FSL1H270J	CHIP C	27PF	J
C129,130			CC73FSL1H101J	CHIP C	100PF	J
C131,132			CC73FSL1H470J	CHIP C	47PF	J
C133,134			CE04KW1V4R7M	ELECTRO	4.7UF	35WV
C135,136			CE04KW1H100M	ELECTRO	10UF	50WV
C137,138			CC73FSL1H270J	CHIP C	27PF	J
C139-142			CC73FSL1H101J	CHIP C	100PF	J
C143-146			CE04KW1HR33M	ELECTRO	0.33UF	50WV
C147-150			CQ93FMG1H223J	MYLAR	0.022UF	J
C151,152			CE04KW1H010M	ELECTRO	1.0UF	50WV
C157,158			CE04KW1H3R3M	ELECTRO	3.3UF	50WV
C159,160			CC73FSL1H270J	CHIP C	27PF	J
C161,162			CC73FSL1H101J	CHIP C	100PF	J
C163,164			CE04KW1V330M	ELECTRO	33UF	35WV
C165,166			CC73FSL1H151J	CHIP C	150PF	J
C167-172			CC73FSL1H101J	CHIP C	100PF	J
C175,176			CE04KW1V4R7M	ELECTRO	4.7UF	35WV
C177,178			CE04KW1H2R2M	ELECTRO	2.2UF	50WV
C179,180			CC73FSL1H270J	CHIP C	27PF	J
C181,182			CC73FSL1H101J	CHIP C	100PF	J
C183,184			CC73FSL1H470J	CHIP C	47PF	J
C185,186			CE04KW1V4R7M	ELECTRO	4.7UF	35WV
C187-190			CE04KW1H010M	ELECTRO	1.0UF	50WV
C191,192			CC73FSL1H270J	CHIP C	27PF	J
C193,194			CC73FSL1H101J	CHIP C	100PF	J
C195,196			CE04KW1V330M	ELECTRO	33UF	35WV
C197,198			CC73FSL1H151J	CHIP C	150PF	J
C221-226			CK73FB1H103K	CHIP C	0.010UF	K
C227-229			CC73FSL1H221J	CHIP C	220PF	J
C230-233			CK73FB1H103K	CHIP C	0.010UF	K
C234-236			CC73FSL1H221J	CHIP C	220PF	J
C237,238			CK73FB1H103K	CHIP C	0.010UF	K
C241-246			CK73FB1H103K	CHIP C	0.010UF	K
C247-249			CC73FSL1H221J	CHIP C	220PF	J
C250-253			CK73FB1H103K	CHIP C	0.010UF	K
C254-256			CC73FSL1H221J	CHIP C	220PF	J
C257-264			CK73FB1H103K	CHIP C	0.010UF	K
C265-267			CC73FSL1H221J	CHIP C	220PF	J
C268-271			CK73FB1H103K	CHIP C	0.010UF	K
C272-274			CC73FSL1H221J	CHIP C	220PF	J
C275-282			CK73FB1H103K	CHIP C	0.010UF	K
C283-285			CC73FSL1H221J	CHIP C	220PF	J
C286,287			CK73FB1H103K	CHIP C	0.010UF	K
C288			CE04KW1H100M	ELECTRO	10UF	50WV
C289			CE04KW1E470M	ELECTRO	47UF	25WV
C293			CE04KW1E221M	ELECTRO	220UF	25WV
C295-300			CE04KW1H100M	ELECTRO	10UF	50WV
C301-308			CE04KW1E470M	ELECTRO	47UF	25WV
C341-368			CC73FSL1H151J	CHIP C	150PF	J
C369,370			CC73FSL1H101J	CHIP C	100PF	J

L : Scandinavia K : USA P : Canada R : Mexico
Y : PX(Far East, Hawaii) T : Europe E : Europe G : Germany
Y : AAFES(Europe) X : Australia M : Other Areas

△ indicates safety critical components.

PARTS LIST

New Parts

Parts without **Parts No.** are not supplied.
Les articles non mentionnés dans le **Parts No.** ne sont pas fournis.
Teile ohne **Parts No.** werden nicht geliefert.

23

Ref. No	Address	New Parts	Parts No.	Description	Destination	Re-marks
C371,372			CE04KW1H100M	ELECTRO 10UF 50WV		
C373-376			CK73FB1H102K	CHIP C 1000PF K		
C377,378			CK73FB1H471K	CHIP C 470PF K		
C379,380			CE04KW0J331M	ELECTRO 330UF 6.3WV		
C381,382			CQ93FMG1H123J	MYLAR 0.012UF J		
C383,384			CQ93FMG1H332J	MYLAR 3300PF J		
C385,386			CE04KW1H100M	ELECTRO 10UF 50WV		
C387,388			CC73FSL1H101J	CHIP C 100PF J		
C389,390			CK73FB1H102K	CHIP C 1000PF K		
C391,392			CE04KW1H100M	ELECTRO 10UF 50WV		
C393,394			CK73FB1H103K	CHIP C 0.010UF K		
C395,396			CE04KW1H100M	ELECTRO 10UF 50WV		
C397-400			CC73FSL1H101J	CHIP C 100PF J		
C401,402			CE04KW1H100M	ELECTRO 10UF 50WV		
C403,404			CC73FSL1H101J	CHIP C 100PF J		
C405,406			CE04KW1H100M	ELECTRO 10UF 50WV		
C407,408			CC73FSL1H101J	CHIP C 100PF J		
C409,410			CE04KW1H100M	ELECTRO 10UF 50WV		
C411,412			CK73FB1H103K	CHIP C 0.010UF K		
C413,414			CE04KW1H100M	ELECTRO 10UF 50WV		
C415-418			CC73FSL1H101J	CHIP C 100PF J		
C419,420			CE04KW1E101M	ELECTRO 100UF 25WV		
C421,422			CC73FSL1H101J	CHIP C 100PF J		
C423,424			CE04KW1H100M	ELECTRO 10UF 50WV		
C425,426			CC73FSL1H101J	CHIP C 100PF J		
C427,428			CE04KW1H100M	ELECTRO 10UF 50WV		
C451,452			CE04KW1E470M	ELECTRO 47UF 25WV		
C453,454			CK73FB1H103K	CHIP C 0.010UF K		
C455-457			CC73FSL1H221J	CHIP C 220PF J		
C458,459			CK73FB1H103K	CHIP C 0.010UF K		
C460-462			CC73FSL1H221J	CHIP C 220PF J		
C463,464			CK73FB1H103K	CHIP C 0.010UF K		
C465-470			CC73FSL1H221J	CHIP C 220PF J		
C471-478			CE04KW1V220M	ELECTRO 22UF 35WV		
C501-506			CK73FB1H103K	CHIP C 0.010UF K		
C511			CE04KW1H100M	ELECTRO 10UF 50WV		
C512-515			CE04KW1E470M	ELECTRO 47UF 25WV		
C516-523			CC73FSL1H101J	CHIP C 100PF J		
C524-535			CE04KW1H100M	ELECTRO 10UF 50WV		
C536-538			CK73FB1H103K	CHIP C 0.010UF K		
CN1			E40-4914-05	FLAT CABLE CONNECTOR		
CN2			E40-4906-05	FLAT CABLE CONNECTOR		
CN3			E40-4293-05	FLAT CABLE CONNECTOR		
J1 -3			E63-0070-15	PHONO JACK		
J4			E63-0047-15	PHONO JACK		
J5			E63-0180-05	PHONO JACK		
J6			E63-0181-05	PHONO JACK		
R1,2			RK73FB2A104J	CHIP R 100K J 1/10W		
R3,4			RK73FB2A223J	CHIP R 22K J 1/10W		
R5,6			RK73FB2A912J	CHIP R 9.1K J 1/10W		
R11,12			RK73FB2A244J	CHIP R 240K J 1/10W		
R13,14			RK73FB2A113J	CHIP R 11K J 1/10W		
R15,16			RK73FB2A223J	CHIP R 22K J 1/10W		
R17,18			RK73FB2A104J	CHIP R 100K J 1/10W		

L : Scandinavia
Y : PX(Far East, Hawaii)
Y : AAFES(Europe)

K : USA
T : Europe
X : Australia

P : Canada
E : Europe
M : Other Areas

R : Mexico
G : Germany

△ indicates safety critical components.

New Parts

Parts without **Parts No.** are not supplied.
Les articles non mentionnés dans le **Parts No.** ne sont pas fournis.
Teile ohne **Parts No.** werden nicht geliefert.

24

Ref. No	Address	New Parts	Parts No.	Description	Destination	Re-marks
R19,20			RK73FB2A244J	CHIP R 240K J 1/10W		
R21,22			RK73FB2A104J	CHIP R 100K J 1/10W		
R23,24			RK73FB2A222J	CHIP R 2.2K J 1/10W		
R25-28			RK73FB2A304J	CHIP R 300K J 1/10W		
R29,30			RK73FB2A563J	CHIP R 56K J 1/10W		
R31,32			RK73FB2A101J	CHIP R 100 J 1/10W		
R33-40			RK73FB2A562J	CHIP R 5.6K J 1/10W		
R41-44			RK73FB2A561J	CHIP R 560 J 1/10W		
R45,46			RK73FB2A114J	CHIP R 110K J 1/10W		
R47,48			RK73FB2A201J	CHIP R 200 J 1/10W		
R49,50			RK73FB2A512J	CHIP R 5.1K J 1/10W		
R51,52			RK73FB2A272J	CHIP R 2.7K J 1/10W		
R53,54			RK73FB2A132J	CHIP R 1.3K J 1/10W		
R55,56			RK73FB2A681J	CHIP R 680 J 1/10W		
R57,58			RK73FB2A201J	CHIP R 200 J 1/10W		
R59,60			RK73FB2A512J	CHIP R 5.1K J 1/10W		
R61,62			RK73FB2A272J	CHIP R 2.7K J 1/10W		
R63,64			RK73FB2A132J	CHIP R 1.3K J 1/10W		
R65-68			RK73FB2A681J	CHIP R 680 J 1/10W		
R69,70			RK73FB2A132J	CHIP R 1.3K J 1/10W		
R71,72			RK73FB2A272J	CHIP R 2.7K J 1/10W		
R73,74			RK73FB2A201J	CHIP R 200 J 1/10W		
R75,76			RK73FB2A512J	CHIP R 5.1K J 1/10W		
R77,78			RK73FB2A201J	CHIP R 200 J 1/10W		
R79,80			RK73FB2A512J	CHIP R 5.1K J 1/10W		
R81,82			RK73FB2A272J	CHIP R 2.7K J 1/10W		
R83,84			RK73FB2A132J	CHIP R 1.3K J 1/10W		
R85,86			RK73FB2A681J	CHIP R 680 J 1/10W		
R87-90			RK73FB2A105J	CHIP R 1.0M J 1/10W		
R91,92			RK73FB2A222J	CHIP R 2.2K J 1/10W		
R93,94			RK73FB2A162J	CHIP R 1.6K J 1/10W		
R95,96			RK73FB2A474J	CHIP R 470K J 1/10W		
R97,98			RK73FB2A682J	CHIP R 6.8K J 1/10W		
R99,100			RK73FB2A224J	CHIP R 220K J 1/10W		
R111,112			RK73FB2A151J	CHIP R 150 J 1/10W		
R113,114			RK73FB2A104J	CHIP R 100K J 1/10W		
R115,116			RK73FB2A223J	CHIP R 22K J 1/10W		
R117,118			RK73FB2A912J	CHIP R 9.1K J 1/10W		
R123,124			RK73FB2A244J	CHIP R 240K J 1/10W		
R125,126			RK73FB2A113J	CHIP R 11K J 1/10W		
R127,128			RK73FB2A223J	CHIP R 22K J 1/10W		
R129,130			RK73FB2A104J	CHIP R 100K J 1/10W		
R131,132			RK73FB2A244J	CHIP R 240K J 1/10W		
R133,134			RK73FB2A104J	CHIP R 100K J 1/10W		
R135,136			RK73FB2A101J	CHIP R 100 J 1/10W		
R137-140			RK73FB2A244J	CHIP R 240K J 1/10W		
R141,142			RK73FB2A563J	CHIP R 56K J 1/10W		
R143,144			RK73FB2A101J	CHIP R 100 J 1/10W		
R145-152			RK73FB2A562J	CHIP R 5.6K J 1/10W		
R153-156			RK73FB2A561J	CHIP R 560 J 1/10W		
R157,158			RK73FB2A201J	CHIP R 200 J 1/10W		
R159,160			RK73FB2A512J	CHIP R 5.1K J 1/10W		
R161,162			RK73FB2A272J	CHIP R 2.7K J 1/10W		
R163,164			RK73FB2A132J	CHIP R 1.3K J 1/10W		
R165,166			RK73FB2A681J	CHIP R 680 J 1/10W		

L : Scandinavia
Y : PX(Far East, Hawaii)
Y : AAFES(Europe)

K : USA
T : Europe
X : Australia

P : Canada
E : Europe
M : Other Areas

R : Mexico
G : Germany

△ indicates safety critical components.

PARTS LIST

New Parts
Parts without **Parts No.** are not supplied.
Les articles non mentionnés dans le **Parts No.** ne sont pas fournis.
Teile ohne **Parts No.** werden nicht geliefert.

25

Ref. No	Add-ress	New Parts	Parts No.	Description	Desti-nation	Re-marks
R167,168			RK73FB2A201J	CHIP R 200 J 1/10W		
R169,170			RK73FB2A512J	CHIP R 5.1K J 1/10W		
R171,172			RK73FB2A272J	CHIP R 2.7K J 1/10W		
R173,174			RK73FB2A132J	CHIP R 1.3K J 1/10W		
R175-178			RK73FB2A681J	CHIP R 680 J 1/10W		
R179,180			RK73FB2A132J	CHIP R 1.3K J 1/10W		
R181			RK73FB2A201J	CHIP R 200 J 1/10W		
R182			RK73FB2A272J	CHIP R 2.7K J 1/10W		
R183			RK73FB2A512J	CHIP R 5.1K J 1/10W		
R184,185			RK73FB2A201J	CHIP R 200 J 1/10W		
R186,187			RK73FB2A512J	CHIP R 5.1K J 1/10W		
R188			RK73FB2A201J	CHIP R 200 J 1/10W		
R189			RK73FB2A272J	CHIP R 2.7K J 1/10W		
R190			RK73FB2A512J	CHIP R 5.1K J 1/10W		
R191,192			RK73FB2A272J	CHIP R 2.7K J 1/10W		
R193,194			RK73FB2A132J	CHIP R 1.3K J 1/10W		
R195,196			RK73FB2A681J	CHIP R 680 J 1/10W		
R199,200			RK73FB2A114J	CHIP R 110K J 1/10W		
R201,202			RK73FB2A222J	CHIP R 2.2K J 1/10W		
R203,204			RK73FB2A162J	CHIP R 1.6K J 1/10W		
R205,206			RK73FB2A114J	CHIP R 110K J 1/10W		
R207,208			RK73FB2A682J	CHIP R 6.8K J 1/10W		
R209,210			RK73FB2A224J	CHIP R 220K J 1/10W		
R211,212			RK73FB2A151J	CHIP R 150 J 1/10W		
R213,214			RK73FB2A104J	CHIP R 100K J 1/10W		
R215,216			RK73FB2A223J	CHIP R 22K J 1/10W		
R217,218			RK73FB2A912J	CHIP R 9.1K J 1/10W		
R223,224			RK73FB2A244J	CHIP R 240K J 1/10W		
R225,226			RK73FB2A113J	CHIP R 11K J 1/10W		
R227,228			RK73FB2A223J	CHIP R 22K J 1/10W		
R229,230			RK73FB2A104J	CHIP R 100K J 1/10W		
R231,232			RK73FB2A244J	CHIP R 240K J 1/10W		
R233,234			RK73FB2A104J	CHIP R 100K J 1/10W		
R235,236			RK73FB2A101J	CHIP R 100 J 1/10W		
R237-240			RK73FB2A244J	CHIP R 240K J 1/10W		
R241,242			RK73FB2A563J	CHIP R 56K J 1/10W		
R243,244			RK73FB2A101J	CHIP R 100 J 1/10W		
R245-252			RK73FB2A562J	CHIP R 5.6K J 1/10W		
R253-256			RK73FB2A561J	CHIP R 560 J 1/10W		
R257,258			RK73FB2A201J	CHIP R 200 J 1/10W		
R259,260			RK73FB2A512J	CHIP R 5.1K J 1/10W		
R261,262			RK73FB2A272J	CHIP R 2.7K J 1/10W		
R263,264			RK73FB2A132J	CHIP R 1.3K J 1/10W		
R265,266			RK73FB2A681J	CHIP R 680 J 1/10W		
R267,268			RK73FB2A201J	CHIP R 200 J 1/10W		
R269,270			RK73FB2A512J	CHIP R 5.1K J 1/10W		
R271,272			RK73FB2A272J	CHIP R 2.7K J 1/10W		
R273,274			RK73FB2A132J	CHIP R 1.3K J 1/10W		
R275-278			RK73FB2A681J	CHIP R 680 J 1/10W		
R279,280			RK73FB2A132J	CHIP R 1.3K J 1/10W		
R281,282			RK73FB2A272J	CHIP R 2.7K J 1/10W		
R283,284			RK73FB2A201J	CHIP R 200 J 1/10W		
R285,286			RK73FB2A512J	CHIP R 5.1K J 1/10W		
R287,288			RK73FB2A201J	CHIP R 200 J 1/10W		
R289,290			RK73FB2A512J	CHIP R 5.1K J 1/10W		

L : Scandinavia K : USA P : Canada R : Mexico
Y : PX(Far East, Hawaii) T : Europe E : Europe G : Germany
Y : AAFES(Europe) X : Australia M : Other Areas

⚠ indicates safety critical components.

New Parts
Parts without **Parts No.** are not supplied.
Les articles non mentionnés dans le **Parts No.** ne sont pas fournis.
Teile ohne **Parts No.** werden nicht geliefert.

26

Ref. No	Add-ress	New Parts	Parts No.	Description	Desti-nation	Re-marks
R291,292			RK73FB2A272J	CHIP R 2.7K J 1/10W		
R293,294			RK73FB2A132J	CHIP R 1.3K J 1/10W		
R295,296			RK73FB2A681J	CHIP R 680 J 1/10W		
R299,300			RK73FB2A114J	CHIP R 110K J 1/10W		
R301,302			RK73FB2A222J	CHIP R 2.2K J 1/10W		
R303,304			RK73FB2A162J	CHIP R 1.6K J 1/10W		
R305,306			RK73FB2A114J	CHIP R 110K J 1/10W		
R307,308			RK73FB2A682J	CHIP R 6.8K J 1/10W		
R309,310			RK73FB2A224J	CHIP R 220K J 1/10W		
R311,312			RK73FB2A151J	CHIP R 150 J 1/10W		
R313,314			RK73FB2A104J	CHIP R 100K J 1/10W		
R315,316			RK73FB2A223J	CHIP R 22K J 1/10W		
R317,318			RK73FB2A912J	CHIP R 9.1K J 1/10W		
R323,324			RK73FB2A244J	CHIP R 240K J 1/10W		
R325,326			RK73FB2A113J	CHIP R 11K J 1/10W		
R327,328			RK73FB2A223J	CHIP R 22K J 1/10W		
R329,330			RK73FB2A104J	CHIP R 100K J 1/10W		
R331,332			RK73FB2A244J	CHIP R 240K J 1/10W		
R333,334			RK73FB2A104J	CHIP R 100K J 1/10W		
R335-338			RK73FB2A334J	CHIP R 330K J 1/10W		
R339,340			RK73FB2A222J	CHIP R 2.2K J 1/10W		
R341,342			RK73FB2A102J	CHIP R 1.0K J 1/10W		
R343,344			RK73FB2A334J	CHIP R 330K J 1/10W		
R345,346			RK73FB2A682J	CHIP R 6.8K J 1/10W		
R347,348			RK73FB2A224J	CHIP R 220K J 1/10W		
R349,350			RK73FB2A151J	CHIP R 150 J 1/10W		
R371-391			RK73FB2A101J	CHIP R 100 J 1/10W		
R392			RK73FB2A104J	CHIP R 100K J 1/10W		
R393			RK73FB2A222J	CHIP R 2.2K J 1/10W		
R394			RK73FB2A223J	CHIP R 22K J 1/10W		
R395			RK73FB2A681J	CHIP R 680 J 1/10W		
R405			RK73FB2A222J	CHIP R 2.2K J 1/10W		
R406			RK73FB2A103J	CHIP R 10K J 1/10W		
R408			RK73FB2A222J	CHIP R 2.2K J 1/10W		
R409			RK73FB2A103J	CHIP R 10K J 1/10W		
R411			RK73FB2A222J	CHIP R 2.2K J 1/10W		
R412			RK73FB2A103J	CHIP R 10K J 1/10W		
R414			RK73FB2A222J	CHIP R 2.2K J 1/10W		
R415			RK73FB2A103J	CHIP R 10K J 1/10W		
R417			RK73FB2A222J	CHIP R 2.2K J 1/10W		
R418			RK73FB2A103J	CHIP R 10K J 1/10W		
R420			RK73FB2A222J	CHIP R 2.2K J 1/10W		
R421			RK73FB2A103J	CHIP R 10K J 1/10W		
R451,452			RK73FB2A331J	CHIP R 330 J 1/10W		
R453,454			RK73FB2A474J	CHIP R 470K J 1/10W		
R455,456			RK73FB2A331J	CHIP R 330 J 1/10W		
R457,458			RK73FB2A224J	CHIP R 220K J 1/10W		
R459,460			RK73FB2A331J	CHIP R 330 J 1/10W		
R461,462			RK73FB2A474J	CHIP R 470K J 1/10W		
R463,464			RK73FB2A331J	CHIP R 330 J 1/10W		
R465,466			RK73FB2A224J	CHIP R 220K J 1/10W		
R467,468			RK73FB2A331J	CHIP R 330 J 1/10W		
R469,470			RK73FB2A474J	CHIP R 470K J 1/10W		
R471,472			RK73FB2A331J	CHIP R 330 J 1/10W		
R473,474			RK73FB2A224J	CHIP R 220K J 1/10W		

L : Scandinavia K : USA P : Canada R : Mexico
Y : PX(Far East, Hawaii) T : Europe E : Europe G : Germany
Y : AAFES(Europe) X : Australia M : Other Areas

⚠ indicates safety critical components.

PARTS LIST

New Parts
Parts without **Parts No.** are not supplied.
Les articles non mentionnés dans le **Parts No.** ne sont pas fournis.
Teile ohne **Parts No.** werden nicht geliefert.

27

Ref. No	Add-ress	New Parts	Parts No.	Description	Desti-nation	Re-marks
R475,476			RK73FB2A331J	CHIP R 330 J 1/10W		
R477,478			RK73FB2A224J	CHIP R 220K J 1/10W		
R479,480			RK73FB2A331J	CHIP R 330 J 1/10W		
R481,482			RK73FB2A224J	CHIP R 220K J 1/10W		
R483,484			RK73FB2A331J	CHIP R 330 J 1/10W		
R485,486			RK73FB2A224J	CHIP R 220K J 1/10W		
R487,488			RK73FB2A331J	CHIP R 330 J 1/10W		
R489,490			RK73FB2A224J	CHIP R 220K J 1/10W		
R491,492			RK73FB2A331J	CHIP R 330 J 1/10W		
R493,494			RK73FB2A474J	CHIP R 470K J 1/10W		
R495,496			RK73FB2A331J	CHIP R 330 J 1/10W		
R497,498			RK73FB2A224J	CHIP R 220K J 1/10W		
R499,500			RK73FB2A331J	CHIP R 330 J 1/10W		
R501,502			RK73FB2A474J	CHIP R 470K J 1/10W		
R503,504			RK73FB2A331J	CHIP R 330 J 1/10W		
R505,506			RK73FB2A224J	CHIP R 220K J 1/10W		
R507,508			RK73FB2A102J	CHIP R 1.0K J 1/10W		
R509,510			RK73FB2A473J	CHIP R 47K J 1/10W		
R511,512			RK73FB2A101J	CHIP R 100 J 1/10W		
R513,514			RK73FB2A102J	CHIP R 1.0K J 1/10W		
R515,516			RK73FB2A331J	CHIP R 330 J 1/10W		
R517,518			RK73FB2A274J	CHIP R 270K J 1/10W		
R519,520			RK73FB2A223J	CHIP R 22K J 1/10W		
R521,522			RK73FB2A333J	CHIP R 33K J 1/10W		
R523,524			RK73FB2A331J	CHIP R 330 J 1/10W		
R525,526			RK73FB2A104J	CHIP R 100K J 1/10W		
R527,528			RK73FB2A331J	CHIP R 330 J 1/10W		
R531,532			RK73FB2A224J	CHIP R 220K J 1/10W		
R533,536			RK73FB2A104J	CHIP R 100K J 1/10W		
R537,538			RK73FB2A331J	CHIP R 330 J 1/10W		
R539,540			RK73FB2A224J	CHIP R 220K J 1/10W		
R541,542			RK73FB2A104J	CHIP R 100K J 1/10W		
R545,546			RK73FB2A331J	CHIP R 330 J 1/10W		
R547,548			RK73FB2A224J	CHIP R 220K J 1/10W		
R549,552			RK73FB2A104J	CHIP R 100K J 1/10W		
R553,554			RK73FB2A331J	CHIP R 330 J 1/10W		
R555,556			RK73FB2A224J	CHIP R 220K J 1/10W		
R557,558			RK73FB2A104J	CHIP R 100K J 1/10W		
R559,560			RK73FB2A152J	CHIP R 1.5K J 1/10W		
R561,562			RK73FB2A122J	CHIP R 1.2K J 1/10W		
R563,564			RK73FB2A102J	CHIP R 1.0K J 1/10W		
R565,566			RK73FB2A392J	CHIP R 3.9K J 1/10W		
R567,568			RK73FB2A224J	CHIP R 220K J 1/10W		
R601,602			RD14NB2E820J	RD 82 J 1/4W		
R603,604			RK73FB2A392J	CHIP R 3.9K J 1/10W		
R605,606			RK73FB2A363J	CHIP R 36K J 1/10W		
R607,618			RK73FB2A101J	CHIP R 100 J 1/10W		
R651,658			RK73FB2A104J	CHIP R 100K J 1/10W		
R659,660			RK73FB2A102J	CHIP R 1.0K J 1/10W		
R661,662			RK73FB2A302J	CHIP R 3.0K J 1/10W		
R663,664			RK73FB2A102J	CHIP R 1.0K J 1/10W		
R665,666			RK73FB2A302J	CHIP R 3.0K J 1/10W		
R667,668			RK73FB2A102J	CHIP R 1.0K J 1/10W		
R669,670			RK73FB2A302J	CHIP R 3.0K J 1/10W		
R681			RK73FB2A823J	CHIP R 82K J 1/10W		

L : Scandinavia K : USA P : Canada R : Mexico
Y : PX(Far East, Hawaii) T : Europe E : Europe G : Germany
Y : AAFES(Europe) X : Australia M : Other Areas

⚠ indicates safety critical components.

New Parts
Parts without **Parts No.** are not supplied.
Les articles non mentionnés dans le **Parts No.** ne sont pas fournis.
Teile ohne **Parts No.** werden nicht geliefert.

28

Ref. No	Add-ress	New Parts	Parts No.	Description	Desti-nation	Re-marks
R683			RK73FB2A104J	CHIP R 100K J 1/10W		
R701			RK73FB2A202J	CHIP R 2.0K J 1/10W		
R702			RK73FB2A302J	CHIP R 3.0K J 1/10W		
R703,704			RK73FB2A103J	CHIP R 10K J 1/10W		
R705,706			RK73FB2A132J	CHIP R 1.3K J 1/10W		
R707			RK73FB2A243J	CHIP R 24K J 1/10W		
R708			RK73FB2A103J	CHIP R 10K J 1/10W		
R709			RK73FB2A123J	CHIP R 12K J 1/10W		
R710			RK73FB2A132J	CHIP R 1.3K J 1/10W		
R711,712			RK73FB2A103J	CHIP R 10K J 1/10W		
R713,714			RK73FB2A132J	CHIP R 1.3K J 1/10W		
R715,716			RK73FB2A103J	CHIP R 10K J 1/10W		
R717,718			RK73FB2A132J	CHIP R 1.3K J 1/10W		
K1 -6			S76-0027-05	MAGNETIC RELAY		
D1,2			DAN202U	DIODE		
D4 -11			DAN202U	DIODE		
D21 -31			DA204U	DIODE		
D32 -35			U1BC44	DIODE		
D36 -38			DA204U	DIODE		
IC1,2			NJM4580E	ANALOGUE IC		
IC3			TC9212F	MOS-IC		
IC4,5			NJM4580E	ANALOGUE IC		
IC6			TC9212F	MOS-IC		
IC7,8			NJM4580E	ANALOGUE IC		
IC9			TC9212F	MOS-IC		
IC10,11			NJM4580E	ANALOGUE IC		
IC12			TC9212F	MOS-IC		
IC13			NJM4580E	ANALOGUE IC		
IC14			TC9274F-009	MOS-IC		
IC15			NJM4580E	ANALOGUE IC		
IC16			TC9274F-009	MOS-IC		
IC17			NJM4580E	ANALOGUE IC		
IC18			TC9274F-009	MOS-IC		
IC19			NJM4580E	ANALOGUE IC		
IC21-28			NJM4580E	ANALOGUE IC		
IC29			TC9162AF	MOS-IC		
IC30			TC9164AF	MOS-IC		
IC31			TC9163AF	MOS-IC		
IC32			TC9164AF	MOS-IC		
IC33-35			LC4966	IC(CMOS LOGIC BILATERAL SW)		
△ IC37			TA79015S	IC(VOLTAGE REGULATOR/ -15V)		
△ IC37			UPC7915HF	IC(VOLTAGE REGULATOR/ -15V)		
△ IC38			TA7815S	IC(VOLTAGE REGULATOR/ +15V)		
△ IC38			UPC7815AHF	IC(VOLTAGE REGULATOR/ +15V)		
Q3,4			2SC2878(B)	TRANSISTOR		
Q7,8			2SC2878(B)	TRANSISTOR		
Q11,12			2SC2878(B)	TRANSISTOR		
Q15,16			2SC2878(B)	TRANSISTOR		
Q41			DTC143TS	DIGITAL TRANSISTOR		
Q41			UN4216	DIGITAL TRANSISTOR		
Q42			DTA124ES	DIGITAL TRANSISTOR		
Q42			UN4112	DIGITAL TRANSISTOR		
Q43			DTC143TS	DIGITAL TRANSISTOR		
Q43			UN4216	DIGITAL TRANSISTOR		

L : Scandinavia K : USA P : Canada R : Mexico
Y : PX(Far East, Hawaii) T : Europe E : Europe G : Germany
Y : AAFES(Europe) X : Australia M : Other Areas

⚠ indicates safety critical components.

PARTS LIST

Än New Parts

Parts without **Parts No.** are not supplied.

Les articles non mentionnés dans le **Parts No.** ne sont pas fournis.

Teile ohne **Parts No.** werden nicht geliefert.

29

Ref. No	Add-ress	New Parts	Parts No.	Description	Desti-nation	Re-marks
Q44			DTA124ES	DIGITAL TRANSISTOR		
Q44			UN4112	DIGITAL TRANSISTOR		
Q52 -57			2SC2003(L,K)	TRANSISTOR		
Q70			2SA1534A(R,S)	TRANSISTOR		
Q71			2SC3940A(R,S)	TRANSISTOR		
Q72			DTC124ES	DIGITAL TRANSISTOR		
Q72			UN4212	DIGITAL TRANSISTOR		
Q73			DTC143TS	DIGITAL TRANSISTOR		
Q73			UN4216	DIGITAL TRANSISTOR		
Q74			DTA124ES	DIGITAL TRANSISTOR		
Q74			UN4112	DIGITAL TRANSISTOR		
DISPLAY UNIT (X14-4150-XX)						
D51 -59		Än	B30-2479-05	LED(BLUE)		
D60			B30-2463-05	LED		
D61 ,62			B30-1291-05	LED		
D63			B30-2463-05	LED		
D64 ,65			B30-0432-05	LED(LN31GCPH(U))		
D66			B30-2463-05	LED		
C1 ,2			CC45FSL1H470J	CERAMIC 47PF J		
C3 -8			C91-0737-05	CERAMIC 47PF J		
C9			CE04KW1A101M	ELECTRO 100UF 10WV		
C10			CK45FF1H103Z	CERAMIC 0.010UF Z		
C11			CE04KW1A101M	ELECTRO 100UF 10WV		
C12			CK45FF1H103Z	CERAMIC 0.010UF Z		
C13 ,14			CE04KW1C330M	ELECTRO 33UF 16WV		
C15			CE04KW1A101M	ELECTRO 100UF 10WV		
C16 ,17			CK45FF1H103Z	CERAMIC 0.010UF Z		
C18			CE04KW1A101M	ELECTRO 100UF 10WV		
C19			CK45FF1H103Z	CERAMIC 0.010UF Z		
C20 ,21			CE04KW1A101M	ELECTRO 100UF 10WV		
C22			CK45FF1H103Z	CERAMIC 0.010UF Z		
C23			CE04KW1C330M	ELECTRO 33UF 16WV		
C24			CE04KW1A101M	ELECTRO 100UF 10WV		
C25			CK45FF1H103Z	CERAMIC 0.010UF Z		
C26			CE04KW1A101M	ELECTRO 100UF 10WV		
C27			CK45FF1H103Z	CERAMIC 0.010UF Z		
C28			CE04KW1A101M	ELECTRO 100UF 10WV		
C29			CK45FF1H103Z	CERAMIC 0.010UF Z		
C30			CE04KW1A101M	ELECTRO 100UF 10WV		
C31			CK45FF1H103Z	CERAMIC 0.010UF Z		
C32			CE04KW1A101M	ELECTRO 100UF 10WV		
C33			CK45FF1H103Z	CERAMIC 0.010UF Z		
C34			CE04KW1A101M	ELECTRO 100UF 10WV		
C35 ,36			CK45FF1H103Z	CERAMIC 0.010UF Z		
C37			CE04KW1A101M	ELECTRO 100UF 10WV		
C38			CK45FF1H103Z	CERAMIC 0.010UF Z		
C39			CE04KW1A101M	ELECTRO 100UF 10WV		
C40 ,41			CC45FSL1H470J	CERAMIC 47PF J		
C42 -47			CK45FB1H471K	CERAMIC 470PF K		
C48			CC45FSL1H221J	CERAMIC 220PF J		
C49			C91-0737-05	CERAMIC 47PF J		
C51			CK45FF1H103Z	CERAMIC 0.010UF Z		
C52			C90-3222-05	ELECTRO 100UF 10WV		

L : Scandinavia

K : USA

P : Canada

R : Mexico

Y : PX(Far East, Hawaii)

T : Europe

E : Europe

G : Germany

Y : AAFES(Europe)

X : Australia

M : Other Areas

⚠ indicates safety critical components.

Än New Parts

Parts without **Parts No.** are not supplied.

Les articles non mentionnés dans le **Parts No.** ne sont pas fournis.

Teile ohne **Parts No.** werden nicht geliefert.

30

Ref. No	Add-ress	New Parts	Parts No.	Description	Desti-nation	Re-marks
C53			CK45FB1H102K	CERAMIC 1000PF K		
C54			CK45FF1H472Z	CERAMIC 4700PF Z		
C55			C90-3222-05	ELECTRO 100UF 10WV		
C56			CK45FF1H103Z	CERAMIC 0.010UF Z		
C57			CK45FB1H102K	CERAMIC 1000PF K		
C58			CK45FF1H472Z	CERAMIC 4700PF Z		
C59 ,60			CK45FF1H103Z	CERAMIC 0.010UF Z		
C61 -69			C91-0757-05	CERAMIC 1000PF K		
C70 -73			CK45FB1H102K	CERAMIC 1000PF K		
C101,102			CC45FSL1H101J	CERAMIC 100PF J		
C103,104			C90-3253-05	ELECTRO 1.0UF 50WV		
C105,106			C90-3232-05	ELECTRO 4.7UF 25WV		
C107,108			CK45FF1H103Z	CERAMIC 0.010UF Z		
C109,110			C90-3232-05	ELECTRO 4.7UF 25WV		
C111,112			CK45FB1H102K	CERAMIC 1000PF K		
C113,114			CE04KW1C330M	ELECTRO 33UF 16WV		
C115,116			CC45FSL1H221J	CERAMIC 220PF J		
C117			CK45FB1H102K	CERAMIC 1000PF K		
△ C151,152			C91-1488-05	MF 6800PF 250VAC		
C153			CE04KW1H4R7M	ELECTRO 4.7UF 50WV		
△ C154			C91-1488-05	MF 6800PF 250VAC		
CN1 ,2			E40-4607-05	PIN ASSY		
CN3			E40-4295-05	FLAT CABLE CONNECTOR		
CN4			E40-4808-05	PIN ASSY		
CN5			E40-3268-05	PIN ASSY		
CN6			E40-4396-05	PIN ASSY		
CN7			E40-4245-05	PIN ASSY		
CN8			E40-4293-05	FLAT CABLE CONNECTOR		
CN15			E40-4293-05	FLAT CABLE CONNECTOR		
J1 -3			E63-0094-05	PHONO JACK		
J4 ,5			E56-0011-05	CYLINDRICAL RECEPTACLE		
J6			E58-0013-05	RECTANGULAR RECEPTACLE		
J7			E56-0012-05	CYLINDRICAL RECEPTACLE		
J8			E63-0129-05	PHONO JACK		
△ J11			E03-0112-05	AC OUTLET		K
△ J11			E03-0131-05	AC OUTLET		M
J13			E11-0188-05	MINIATURE PHONE JACK(2P)		
△ F1			F05-4028-05	FUSE (UL) (125V 4A)		K
△ F1 ,2			F05-1222-05	FUSE (SEMKO) (250V T1.25A L)		M
CN9 -12			J13-0075-05	FUSE CLIP		M
CN11,12			J13-0075-05	FUSE CLIP		K
△ R152			R92-1769-05	CARBON 3.3M J 1/2W		K
△ K1			S76-0009-05	MAGNETIC RELAY		
S1 -12			S70-0031-05	TACT SWITCH		
△ S14			S40-1149-05	PUSH SWITCH (POWER TYPE)		
△ S15			S62-0001-05	SLIDE SWITCH		M
S13			T99-0546-05	ROTARY ENCODER		
D1 -48			HSS104	DIODE		
D1 -48			1SS133	DIODE		
D67 -69			HSS104	DIODE		
D67 -69			1SS133	DIODE		

L : Scandinavia

K : USA

P : Canada

R : Mexico

Y : PX(Far East, Hawaii)

T : Europe

E : Europe

G : Germany

Y : AAFES(Europe)

X : Australia

M : Other Areas

⚠ indicates safety critical components.

PARTS LIST

Ãñ New Parts

Parts without **Parts No.** are not supplied.
Les articles non mentionnés dans le **Parts No.** ne sont pas fournis.
Teile ohne **Parts No.** werden nicht geliefert.

31

Ref. No	Add-ress	New Parts	Parts No.	Description	Desti-nation	Re-marks
D71 -83			HZS5.1N(B2)	ZENER DIODE		
D71 -83			RD5.1ES(B2)	ZENER DIODE		
D101-106			HSS104	DIODE		
D101-106			1SS133	DIODE		
D151			HSS104	DIODE		
D151			1SS133	DIODE		
IC1			TC4051BP	IC(8CH MPX/ DE-MPX)		
IC2			TC4052BP	IC(4CH MPX/DE-MPX)		
IC3 -7			NJM2279D	IC(VIDEO IC)		
IC8			NJU3713D	MOS-IC		
IC9			NJU3711D	IC(8BIT I/O EXPANDER)		
IC10			NJM4580L-D	IC(OP AMP X2)		
Q1 -3			DTC113ZS	DIGITAL TRANSISTOR		
Q1 -3			UN4219	DIGITAL TRANSISTOR		
Q4 ,5			2SC2458(Y,GR)	TRANSISTOR		
Q4 ,5			2SC3311A(Q,R)	TRANSISTOR		
Q6 -9			DTC113ZS	DIGITAL TRANSISTOR		
Q6 -9			UN4219	DIGITAL TRANSISTOR		
Q10 ,11			DTA113ZS	DIGITAL TRANSISTOR		
Q10 ,11			UN4119	DIGITAL TRANSISTOR		
Q12			2SC2003(L,K)	TRANSISTOR		
Q13 ,14			DTA113ZS	DIGITAL TRANSISTOR		
Q13 ,14			UN4119	DIGITAL TRANSISTOR		

LCD REMOTE CONTROLLER UNIT (X25-5690-10)

C1			C92-0509-05	CHIP-TAN	10UF	6.3WV
C2			CC73FSL1H101J	CHIP C	100PF	J
C3			CK73EB1H104K	CHIP C	0.10UF	K
C4			CK73FB1H102K	CHIP C	1000PF	K
C5			CC73FCH1H120J	CHIP C	12PF	J
C6 ,7			CC73FSL1H101J	CHIP C	100PF	J
C8			CC73FCH1H820J	CHIP C	82PF	J
C9			CK73FB1H473K	CHIP C	0.047UF	K
C10			CK73FB1H472K	CHIP C	4700PF	K
C11			CK73FB1H102K	CHIP C	1000PF	K
C12			CC73FUJ1H020C	CHIP C	2.0PF	C
C13			CC73FSL1H101J	CHIP C	100PF	J
C14			CC73FUJ1H030C	CHIP C	3.0PF	C
C15			CC73FCH1H1R5C	CHIP C	1.5PF	C
C16			CC73FCH1H030C	CHIP C	3.0PF	C
C17			CK73FB1H102K	CHIP C	1000PF	K
C18 ,19			CC73FCH1H010C	CHIP C	1.0PF	C
C20			CK73FB1H153K	CHIP C	0.015UF	K
C21			CC73FSL1H151J	CHIP C	150PF	J
C22 ,23			CC73FSL1H101J	CHIP C	100PF	J
C24			CK73FB1H102K	CHIP C	1000PF	K
C25			C92-0509-05	CHIP-TAN	10UF	6.3WV
C26			CK73FB1H333K	CHIP C	0.033UF	K
C27 -29			CC73FSL1H101J	CHIP C	100PF	J
C30			CK73FB1H102K	CHIP C	1000PF	K
C31			C92-0509-05	CHIP-TAN	10UF	6.3WV
C32 -34			CK73EB1H104K	CHIP C	0.10UF	K
C35			C92-0505-05	CHIP-TAN	10UF	16WV
C36			CK73EB1C474K	CHIP C	0.47UF	K
C38 -41			CC73FSL1H151J	CHIP C	150PF	J

L : Scandinavia K : USA P : Canada R : Mexico
Y : PX(Far East, Hawaii) T : Europe E : Europe G : Germany
Y : AAFES(Europe) X : Australia M : Other Areas

⚠ indicates safety critical components.

Ãñ New Parts

Parts without **Parts No.** are not supplied.
Les articles non mentionnés dans le **Parts No.** ne sont pas fournis.
Teile ohne **Parts No.** werden nicht geliefert.

32

Ref. No	Add-ress	New Parts	Parts No.	Description	Desti-nation	Re-marks
C42			C92-0509-05	CHIP-TAN	10UF	6.3WV
C43		Ãñ	CK73FB1H102K	CHIP C	1000PF	K
C44			C93-0030-05	CHIP C	0.01UF	J
C45			CK73FB1H333K	CHIP C	0.033UF	K
C46			CC73FSL1H221J	CHIP C	220PF	J
C47			CK73FB1H103K	CHIP C	0.010UF	K
C48			CK73FB1H223K	CHIP C	0.022UF	K
C49			CK73FB1H473K	CHIP C	0.047UF	K
C50			C92-0509-05	CHIP-TAN	10UF	6.3WV
C51 -53			CC73FSL1H101J	CHIP C	100PF	J
C71			CC73FCH1H060D	CHIP C	6.0PF	D
C72			CC73FCH1H330J	CHIP C	33PF	J
C101			CC73FSL1H471J	CHIP C	470PF	J
C102			CK73FB1H103K	CHIP C	0.010UF	K
C103			C92-0505-05	CHIP-TAN	10UF	16WV
C104,105			CK73EB1H104K	CHIP C	0.10UF	K
C106			C92-0509-05	CHIP-TAN	10UF	6.3WV
C107			C92-0031-05	CHIP-ELE	22UF	35WV
C109			CK73EB1H104K	CHIP C	0.10UF	K
C110			C91-1535-05	CHIP C	39PF	J
C111,112			CK73EB1H104K	CHIP C	0.10UF	K
C113			C92-0505-05	CHIP-TAN	10UF	16WV
C114			CC73FCH1H330J	CHIP C	33PF	J
C115,116			CK73FB1H473K	CHIP C	0.047UF	K
C117			C92-0031-05	CHIP-ELE	22UF	35WV
C118-121			CK73EB1H104K	CHIP C	0.10UF	K
C122,123			CC73FCH1H200J	CHIP C	20PF	J
C124-130			CK73EB1H104K	CHIP C	0.10UF	K
C131,132			CK73FB1H102K	CHIP C	1000PF	K
C133,134			CC73FCH1H200J	CHIP C	20PF	J
C135,136			CK73FF1C224Z	CHIP C	0.22UF	Z
C137,138			CK73EB1H104K	CHIP C	0.10UF	K
C139,140			C92-0509-05	CHIP-TAN	10UF	6.3WV
C141-143			CK73EB1H104K	CHIP C	0.10UF	K
C144			C92-0509-05	CHIP-TAN	10UF	6.3WV
C145-147			CK73EB1H104K	CHIP C	0.10UF	K
TC1		Ãñ	C05-0233-05	CERAMIC TRIMMER CAPACITOR(5-20)		
TC2		Ãñ	C05-0228-05	C TRIMMER	1.4-3.0PF	
TC3		Ãñ	C05-0229-05	CERAMIC TRIMMER CAPACITOR(2-6P)		
CN2		Ãñ	E40-9814-05	PIN ASSY		
CN3		Ãñ	E40-9815-05	PIN ASSY		
CN4		Ãñ	E40-9939-05	FLAT CABLE CONNECTOR		
CN5		Ãñ	E40-9370-05	PIN ASSY		
CN101		Ãñ	E02-0015-05	IC SOCKET (IC105)		
E1			J11-0808-05	WIRE CLAMPER		
L1		Ãñ	L33-1273-05	SMALL FIXED INDUCTOR		
L2		Ãñ	L40-6865-35	SMALL FIXED INDUCTOR(6.8NH)		
L4		Ãñ	L40-1075-35	SMALL FIXED INDUCTOR(10NH)		
L5		Ãñ	L33-1274-05	SMALL FIXED INDUCTOR		
L6		Ãñ	L40-1875-35	SMALL FIXED INDUCTOR(18NH)		
L101		Ãñ	L90-0069-05	COIL		
L102		Ãñ	L19-0080-05	TRANSFORMER FOR CONVERTER		
L103		Ãñ	L19-0078-05	TRANSFORMER FOR CONVERTER		
L104		Ãñ	L19-0079-05	TRANSFORMER FOR CONVERTER		

L : Scandinavia K : USA P : Canada R : Mexico
Y : PX(Far East, Hawaii) T : Europe E : Europe G : Germany
Y : AAFES(Europe) X : Australia M : Other Areas

⚠ indicates safety critical components.

PARTS LIST

Ñ New Parts

Parts without **Parts No.** are not supplied.

Les articles non mentionnés dans le **Parts No.** ne sont pas fournis.

Teile ohne **Parts No.** werden nicht geliefert.



Ref. No	Add-ress	New Parts	Parts No.	Description	Desti-nation	Re-marks
X1		Ñ	L77-2164-05	CRYSTAL RESONATOR(12.6MHZ)		
X101		Ñ	L77-2163-05	CRYSTAL RESONATOR(16.667M		
X102		Ñ	L77-2162-05	CRYSTAL RESONATOR(10.000M		
CP101,102		Ñ	R90-0950-05	C MULTI-COM 47 J 1/10W		
CP103		Ñ	R90-0951-05	MULTIPLE RESISTOR		
CP104-106		Ñ	R90-0950-05	C MULTI-COM 47 J 1/10W		
R1_2			RK73FB2A103J	CHIP R 10K J 1/10W		
R3			RK73FB2A151J	CHIP R 150 J 1/10W		
R4 -6			RK73FB2A104J	CHIP R 100K J 1/10W		
R7			RK73FB2A752J	CHIP R 7.5K J 1/10W		
R8			RK73FB2A103J	CHIP R 10K J 1/10W		
R9			RK73FB2A331J	CHIP R 330 J 1/10W		
R10			RK73FB2A103J	CHIP R 10K J 1/10W		
R11			RK73FB2A271J	CHIP R 270 J 1/10W		
R12			RK73FB2A470J	CHIP R 47 J 1/10W		
R13			RK73FB2A390J	CHIP R 39 J 1/10W		
R14			RK73FB2A220J	CHIP R 22 J 1/10W		
R15			RK73FB2A103J	CHIP R 10K J 1/10W		
R16			RK73FB2A101J	CHIP R 100 J 1/10W		
R17			RK73FB2A102J	CHIP R 1.0K J 1/10W		
R18 ,19			RK73FB2A103J	CHIP R 10K J 1/10W		
R20			RK73FB2A331J	CHIP R 330 J 1/10W		
R21			RK73FB2A472J	CHIP R 4.7K J 1/10W		
R22			RK73FB2A682J	CHIP R 6.8K J 1/10W		
R23			RK73FB2A100J	CHIP R 10 J 1/10W		
R24			RK73FB2A181J	CHIP R 180 J 1/10W		
R25 ,26			RK73FB2A103J	CHIP R 10K J 1/10W		
R27			RK73FB2A182J	CHIP R 1.8K J 1/10W		
R28			RK73FB2A274J	CHIP R 270K J 1/10W		
R29			RK73FB2A182J	CHIP R 1.8K J 1/10W		
R30			RK73FB2A184J	CHIP R 180K J 1/10W		
R31			RK73FB2A473J	CHIP R 47K J 1/10W		
R32			RK73FB2A101J	CHIP R 100 J 1/10W		
R33			RK73FB2A102J	CHIP R 1.0K J 1/10W		
R34			RK73FB2A273J	CHIP R 27K J 1/10W		
R35			RK73FB2A183J	CHIP R 18K J 1/10W		
R36			RK73FB2A151J	CHIP R 150 J 1/10W		
R37 ,38			RK73FB2A274J	CHIP R 270K J 1/10W		
R39			RK73FB2A105J	CHIP R 1.0M J 1/10W		
R40			RK73FB2A114J	CHIP R 110K J 1/10W		
R41 ,42			RK73FB2A104J	CHIP R 100K J 1/10W		
R43			RK73FB2A472J	CHIP R 4.7K J 1/10W		
R44			RK73FB2A183J	CHIP R 18K J 1/10W		
R45			RK73FB2A224J	CHIP R 220K J 1/10W		
R46			RK73FB2A101J	CHIP R 100 J 1/10W		
R47			RK73FB2A103J	CHIP R 10K J 1/10W		
R48			RK73FB2A152J	CHIP R 1.5K J 1/10W		
R49			RK73FB2A102J	CHIP R 1.0K J 1/10W		
R50			RK73FB2A101J	CHIP R 100 J 1/10W		
R51			RK73FB2A183J	CHIP R 18K J 1/10W		
R52			RK73FB2A103J	CHIP R 10K J 1/10W		
R53			RK73FB2A750J	CHIP R 75 J 1/10W		
R54			RK73FB2A473J	CHIP R 47K J 1/10W		
R55			RK73FB2A243J	CHIP R 24K J 1/10W		

L : Scandinavia K : USA P : Canada R : Mexico
 Y : PX(Far East, Hawaii) T : Europe E : Europe G : Germany
 Y : AAFES(Europe) X : Australia M : Other Areas

Δ indicates safety critical components.

Ñ New Parts

Parts without **Parts No.** are not supplied.

Les articles non mentionnés dans le **Parts No.** ne sont pas fournis.

Teile ohne **Parts No.** werden nicht geliefert.



Ref. No	Add-ress	New Parts	Parts No.	Description	Desti-nation	Re-marks
R56			RK73FB2A151J	CHIP R 150 J 1/10W		
R57			RK73FB2A100J	CHIP R 10 J 1/10W		
R58			RK73FB2A101J	CHIP R 100 J 1/10W		
R59			RK73FB2A100J	CHIP R 10 J 1/10W		
R60			RK73FB2A470J	CHIP R 47 J 1/10W		
R101,102			RK73FB2A102J	CHIP R 1.0K J 1/10W		
R103			RK73FB2A103J	CHIP R 10K J 1/10W		
R104			RN73FH2A104D	CHIP R 100K D 1/10W		
R105			RN73FH2A105D	CHIP R 1.0M D 1/10W		
R106,107			RN73FH2A104D	CHIP R 100K D 1/10W		
R108		Ñ	R92-1832-05	METAL GLAZE 22 J 1W		
R109			RK73FB2A104J	CHIP R 100K J 1/10W		
R110			RK73FB2A432J	CHIP R 4.3K J 1/10W		
R111,112			RK73FB2A1R0J	CHIP R 1.0 J 1/10W		
R113			RK73FB2A104J	CHIP R 100K J 1/10W		
R114			RK73FB2A223J	CHIP R 22K J 1/10W		
R115			RK73FB2A393J	CHIP R 39K J 1/10W		
R116			RK73FB2A105J	CHIP R 1.0M J 1/10W		
R117			RK73FB2A1R0J	CHIP R 1.0 J 1/10W		
R118,119			RK73FB2A204J	CHIP R 200K J 1/10W		
R120			RK73FB2A105J	CHIP R 1.0M J 1/10W		
R121			RK73FB2A204J	CHIP R 200K J 1/10W		
R123			RK73FB2A100J	CHIP R 10 J 1/10W		
R125			RK73FB2A100J	CHIP R 10 J 1/10W		
R127			RK73FB2A473J	CHIP R 47K J 1/10W		
R128-131			RK73FB2A103J	CHIP R 10K J 1/10W		
R132-134			RK73FB2A472J	CHIP R 4.7K J 1/10W		
R135,136			RK73FB2A104J	CHIP R 100K J 1/10W		
R137-142			RK73FB2A102J	CHIP R 1.0K J 1/10W		
R143-145			RK73FB2A223J	CHIP R 22K J 1/10W		
R150,151			RK73FB2A103J	CHIP R 10K J 1/10W		
R152			RN73FH2A223D	CHIP R 22K D 1/10W		
R153			RN73FH2A103D	CHIP R 10K D 1/10W		
R154			RK73FB2A624J	CHIP R 620K J 1/10W		
R155			RK73FB2A564J	CHIP R 560K J 1/10W		
Δ R156		Ñ	R92-1831-05	FUSE RESIST 0.2 J 1/10W		
R157,158			RN73FH2A104D	CHIP R 100K D 1/10W		
R159			RN73FH2A202D	CHIP R 2.0K D 1/10W		
R160			RN73FH2A751D	CHIP R 750 D 1/10W		
R161			RK73FB2A102J	CHIP R 1.0K J 1/10W		
R162			RK73FB2A473J	CHIP R 47K J 1/10W		
R163			RK73FB2A472J	CHIP R 4.7K J 1/10W		
R164			RK73FB2A104J	CHIP R 100K J 1/10W		
R165			RK73FB2A102J	CHIP R 1.0K J 1/10W		
R166			RK73FB2A1R0J	CHIP R 1.0 J 1/10W		
VR1			R12-8425-05	TRIMMING POT.(22K)		
S101-104			S70-0815-05	TACT SWITCH		
BZ101		Ñ	T95-0142-05	PIEZOELECTRIC VIBRATOR		
D1		Ñ	SVC212(2,3)	VARIABLE CAPACITANCE DIODE		
D2			1S239	VARIABLE CAPACITANCE DIODE		
D3			DA204K	DIODE		
D101,102			DA204K	DIODE		
D103-107			RB160L-40	DIODE		

L : Scandinavia K : USA P : Canada R : Mexico
 Y : PX(Far East, Hawaii) T : Europe E : Europe G : Germany
 Y : AAFES(Europe) X : Australia M : Other Areas

Δ indicates safety critical components.

PARTS LIST

Äñ New Parts

Parts without **Parts No.** are not supplied.

Les articles non mentionnés dans le **Parts No.** ne sont pas fournis.

Teile ohne **Parts No.** werden nicht geliefert.

35

Ref. No	Add- ress	New Parts	Parts No.	Description	Desti- nation	Re- marks
D108			RB411D	DIODE		
IC1			LMX1511TMX	ANALOGUE IC		
IC2		Äñ	MRFIC2001R2	ANALOGUE IC		
IC3		Äñ	TK11250AU	ANALOGUE IC		
IC4			NJM2058M	ANALOGUE IC		
IC5		Äñ	74HCT7046AD	ANALOGUE IC		
IC6		Äñ	NJM324M	ANALOGUE IC		
IC7		Äñ	UPC2708T-E3	ANALOGUE IC		
IC8, 9		Äñ	UPC2748T-E3	ANALOGUE IC		
IC101		Äñ	TK11250AU	ANALOGUE IC		
IC102		Äñ	ML4876CR	ANALOGUE IC		
IC103		Äñ	MM1134BFFE	ANALOGUE IC		
IC104		Äñ	HM62256BLFP8SL	MEMORY IC		
IC105		Äñ	27C40961AAC	MEMORY IC		
IC106		Äñ	MC68307PU16V	MI-COM IC		
IC107			SED1330FBA	DI BI-POLAR IC		
IC108		Äñ	HM62256BLFP8SL	MEMORY IC		
IC109		Äñ	PCF8591T	DI BI-POLAR IC		
IC110		Äñ	S-80727AN-DQ	ANALOGUE IC		
Q1		Äñ	2SC3547A	TRANSISTOR		
Q3, 4			2SA1576	TRANSISTOR		
Q101,102		Äñ	2SK1719	FET		
Q103		Äñ	MMDF2N02ER2	DUAL FET		
Q104		Äñ	2SK1062	FET		
Q105		Äñ	2SK1719	FET		
Q106,107			2SA1576	TRANSISTOR		
BA101		Äñ	W09-1230-05	BATTERY		

L : Scandinavia

Y : PX(Far East, Hawaii)

Y : AAFES(Europe)

K : USA

T : Europe

X : Australia

P : Canada

E : Europe

M : Other Areas

R : Mexico

G : Germany

⚠ indicates safety critical components.

SPECIFICATIONS

Note : Due to product upgrades, specifications may change without notice.

Pre amp section

Total harmonic distortion:

All channels except for Subwoofer channel	0.003%	(1 kHz, 1.0 volt)
	0.003%	(20 Hz ~ 20 kHz, 1.0 volt)
Subwoofer	0.05%	(31.5 Hz, 1.0 volt)

Frequency response

All inputs except for phono input 6 Hz ~ 100 kHz, +0dB, -3dB

Phono "RIAA" response 20 Hz ~ 20 kHz, ± 0.5 dB

Signal-to-noise ratio (IHF '78) :

All inputs except for phono input 101 dB

Phono input (MM) 87 dB

Input Sensitivity/impedance

All inputs except for phono input 200 μ V/47 k-ohms

Phono input (MM) 2.5 μ V/47 k-ohms

Tone Control

BASS ± 10 dB (100 Hz)

Treble ± 10 dB (10 kHz)

Output level/impedance

Surround : All channels except for Subwoofer channel
1.0 volt/180 ohms (1 kHz, 0.003%)

Surround : Subwoofer channel
1.0 volt/180 ohms (31.5 Hz, 0.003%)

Video section

Input level/impedance

All inputs except for S-video input : Composite

1.0 volt peak-to-peak/75

S-video : Luminance signal 1.0 volt peak-to-peak/75

S-video : Chrominance signal 0.286 volt peak-to peak/75

Digital section

Sampling frequency

32 kHz, 44.1 KHz, 48 kHz

Input level/impedance

All inputs : Optical -15 dBm ~ -21 dBm, 660 nm ± 30 nm

All inputs : Coaxial 0.5 volt peak-to-peak / 75

Output level/impedance

Output : Optical -15 dBm ~ -21 dBm, 660 nm ± 30 nm

Output : Coaxial 0.5 volt peak-to-peak / 75

FM tuner section

Tuning frequency range 87.5 ~108 MHz

Useable sensitivity(MONO) 1.2 μ V (75) / 13.2 dBf
(75 kHz deviation, S/N 30 dB)

50 dB quieting sensitivity (STEREO) 32 μ V (75) / 41.2 dBf
(75 kHz deviation)

Total harmonic distortion (1 kHz)

MONO 0.6% (65.2 dBf input)

STEREO 0.7% (65.2 dBf input)

SPECIFICATIONS

Selectivity (± 400 kHz)	50 dB
Stereo Separation (1 kHz)	40 dB
Frequency response	30 Hz ~ 15 kHz, ± 0.5 dB, -3.0 dB

AM tuner section

Tuning frequency range	530 Hz ~ 1700 kHz
Useable sensitivity (30% modulation, S/N 20 dB) 16 μ V / (500 μ V/m)	
Total harmonic distortion	0.7%
signal-to-noise ratio (30% modulation, 1 mV input)	45 dB
Selectivity	30 dB

General

Power consumption	90 W
AC outlet (switched)	3 (total 200 W max.)
Dimensions :	
Width	17-5/16" (440 mm)
Height	6-1/4" (159 mm)
Depth	17-5/16" (440 mm)
Weight (net)	26.9 lb (12.2 kg)

KENWOOD follows a policy of continuous advancements in development. For this reason specifications may be changed without notice.

Note:

Component and circuitry are subject to modification to insure best operation under differing local conditions. This manual is based on the U.S.A. (K) standard, and provides information on regional circuit modification through use of alternate schematic diagrams, and information on regional component variations through use of parts list.

KENWOOD CORPORATION

14-6, Dogenzaka 1-chome, Shibuya-ku, Tokyo, 150 Japan

KENWOOD SERVICE CORPORATION

P.O. BOX 22745, 2201 East Dominguez St., Long Beach, CA 90801-5745, U.S.A.

KENWOOD ELECTRONICS CANADA INC.

6070 Kestrel Road, Mississauga, Ontario, Canada L5T 1S8

KENWOOD ELECTRONICS LATIN AMERICA S.A.

P.O. BOX 55-2791, Piso 6 plaza Chase, Cl. 47 y Aquilino de la Guardia Panama, Republic de Panama

KENWOOD ELECTRONICS U.K. LIMITED

KENWOOD House, Dwight Road, Watford, Herts., WD1 8EB., United Kingdom

KENWOOD ELECTRONICS BENELUX N.V.

Meachelsesteenweg 418, B-1930 Zaventem, Belgium

KENWOOD ELECTRONICS DEUTSCHLAND GMBH

Rembrücker Str. 15, 63150 Heusenstamm, Germany

KENWOOD ELECTRONICS FRANCE S.A.

13 Boulevard Ney, 75018 Paris, France

KENWOOD ELECTRONICS ITALIA S.p.A.

Via G. Sirtori, 7/9 20129, Milano, Italy

KENWOOD IBÉRICA S.A.

Bolivia, 239-08020 Barcelona, Spain

KENWOOD ELECTRONICS AUSTRALIA PTY. LTD. (A.C.N. 001499 074)

P.O. Box 504, 8 Figtree Drive, Australia Centre, Homebush, N.S.W. 2140, Australia

KENWOOD & LEE ELECTRONICS, LTD.

Unit 3712-3724, Level 37, Tower 1, Metroplaza, 223 Hing Fong Road, Kwai Fong N.T., Hong Kong

KENWOOD ELECTRONICS SINGAPORE PTE LTD.

No. 1 Genting Lane #02-02, KENWOOD Building, Singapore, 349544

KENWOOD ELECTRONICS (MALAYSIA) SDN BHD.

#4.01 Level 4, Wisma Academy Lot 4A, Jalan 19/1 46300 Petaling Jaya Selangor Darul Ehsan Malaysia